



REMOVAL PROCEDURE



S E R V I C E M A N U A L

5.0/5.2/5.8/6.8/7.5 kW Class

-  Outdoor Unit
-  Inverter
-  Multi Type



Service Manual Removal Procedure

Outdoor Unit

●Cooling Only

3MKS50E3V1B

3MKS58EVMA

4MKS58E3V1B

4MKS75F2V1B

●Heat Pump

3MXS52E3V1B

3MXS52EVMA

3AMX52E3V1B

3MXS68G2V1B

4MXS68F2V1B

Table of Contents

1. Removal of Outer Panels	2
2. Removal of Electrical Box	6
3. Removal of PCBs	14
4. Removal of Outdoor Fan / Fan Motor	19
5. Removal of Sound Blankets	21
6. Removal of Coils / Thermistors	25
7. Removal of Distributor	28
8. Removal of Four Way Valve	29
9. Removal of Compressor	30



Note:

- The illustrations may be slightly different depending on the model.
- The illustrations are for heat pump models as representative.

1. Removal of Outer Panels

Procedure



Warning

Be sure to wait for 10 minutes or more after turning off all power supplies before disassembling work.

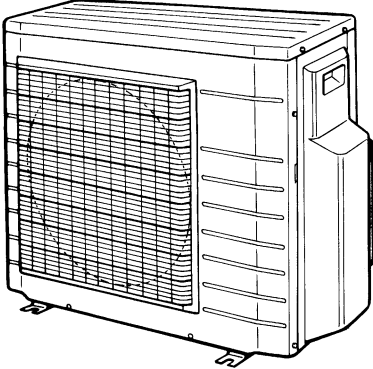
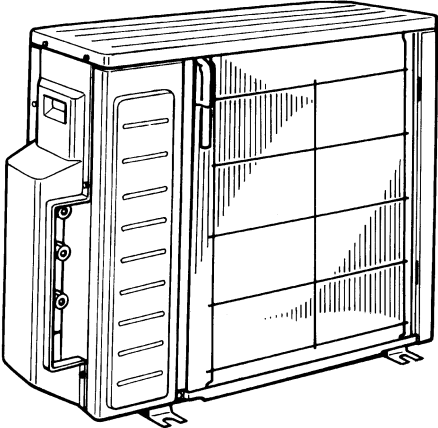
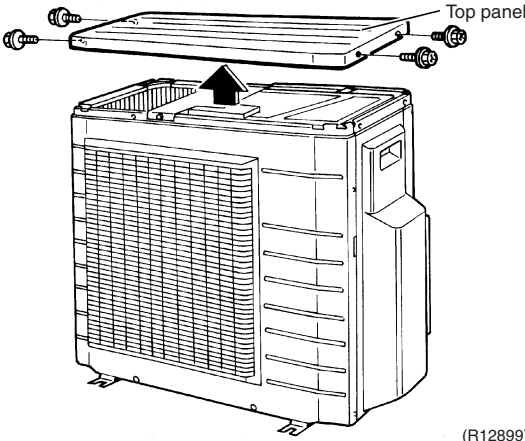
Step	Procedure	Procedure	Points
1	Appearance features	 <p>(R5494)</p>  <p>(R12898)</p>	<ul style="list-style-type: none"> Take care not to cut your finger by the fins of the heat exchanger.
2	Remove the 4 screws (2 on both sides) of the top panel.	 <p>Top panel</p> <p>(R12899)</p>	

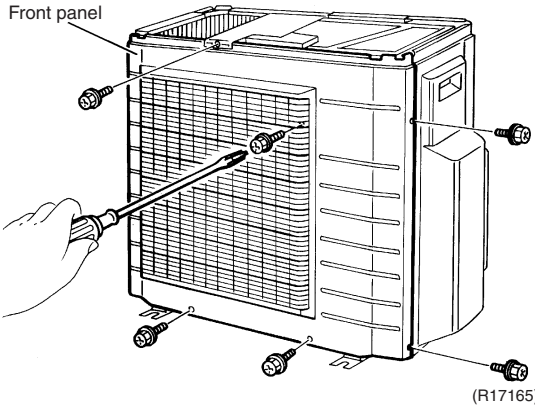
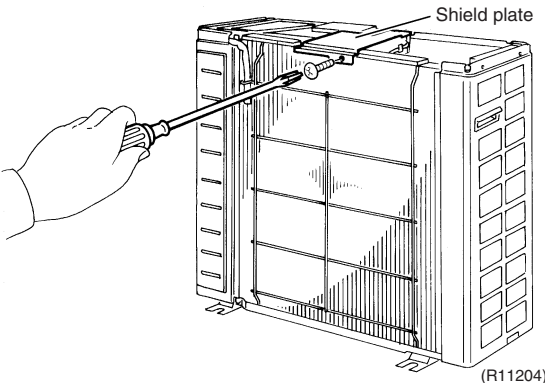
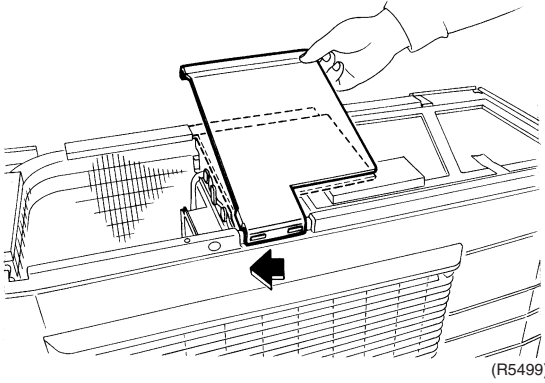
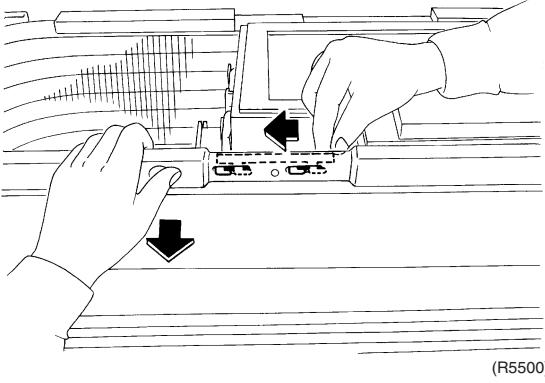
Step	Procedure	Points	
3	Remove the 6 screws of the front panel.	 <p>(R17165)</p>	
4	Remove the screw of the shield plate.	 <p>(R11204)</p>	
5	Slide the shield plate to the left to unfasten the hooks and remove the shield plate.	 <p>(R5499)</p>	
6	Unfasten the upper 2 hooks.	 <p>(R5500)</p>	<ul style="list-style-type: none"> ■ Align the position of hole of the upper hook to pull the front panel out.

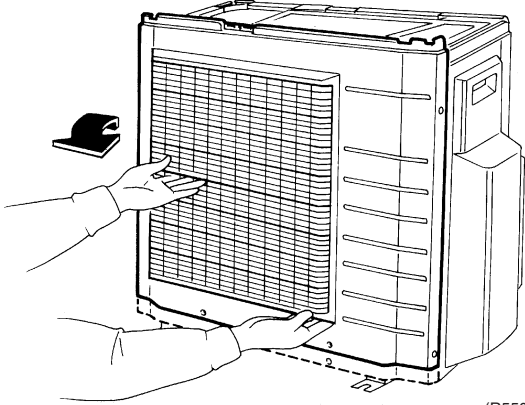
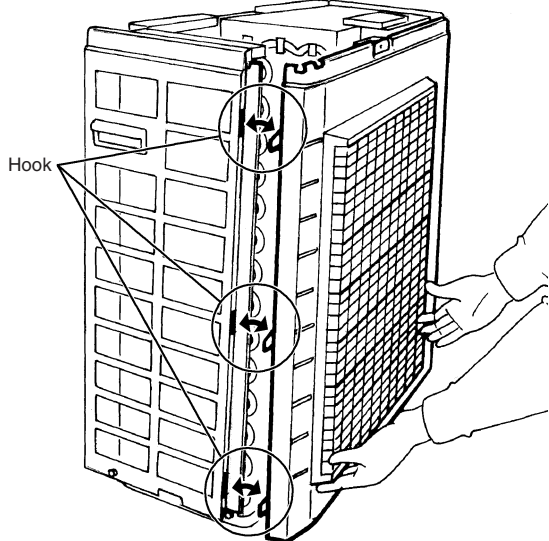
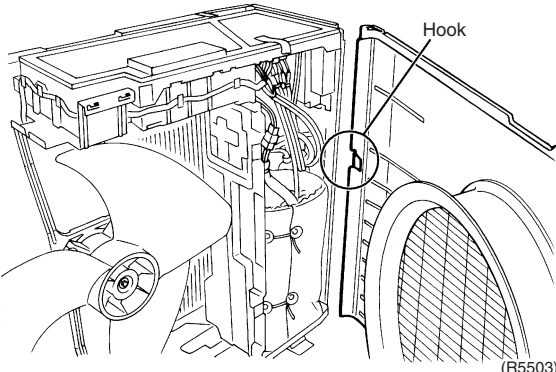
Step	Procedure	Points
7	<p>Lift the front panel up to unfasten the left side hooks.</p>  <p>(R5501)</p>  <p>(R12901)</p>	<p>■ The front panel has 3 hooks on the left.</p>
8	<p>Unfasten the right side hook and remove the front panel.</p>  <p>(R5503)</p>	

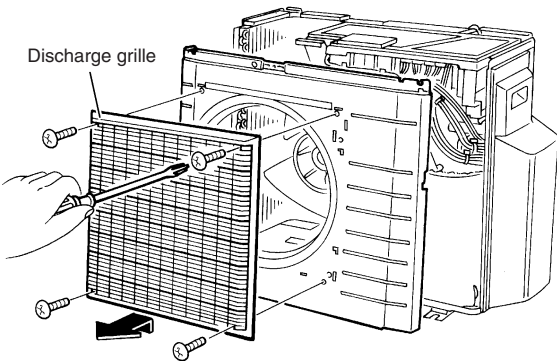
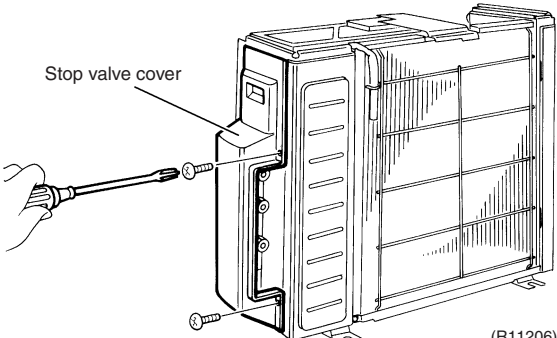
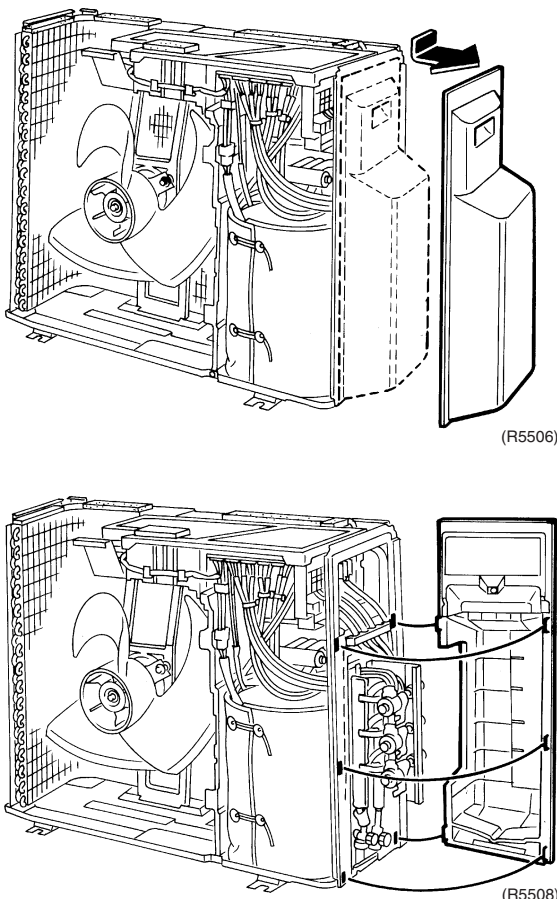
Step		Procedure	Points
9	Remove the 4 screws of the discharge grille.	 <p>Discharge grille</p> <p>(R12902)</p>	
10	Remove the 2 screws of the stop valve cover.	 <p>Stop valve cover</p> <p>(R11206)</p>	
11	Slide the stop valve cover downward and remove it.	 <p>(R5506)</p> <p>(R5508)</p>	<p>■ When reassembling, make sure to fit the 5 hooks.</p>

2. Removal of Electrical Box

Procedure



Warning

Be sure to wait for 10 minutes or more after turning off all power supplies before disassembling work.

Step	Procedure	Points
1. Disconnect the harnesses.		<ul style="list-style-type: none"> ■ The illustrations are for 3-room models as representative, 4-room models also have D port. ■ The wires are fixed to the terminal board with screws. ■ Connecting wires <ul style="list-style-type: none"> (1) Black : Power supply (2) White : Power supply (3) Red : Transmission ■ Power Supply wires <ul style="list-style-type: none"> (L) - Black (N) - White

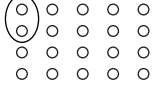
Step	Procedure	Points
2	Detach the fixing tape of the electrical box cover.	
3	Unfasten the 4 hooks at the ▲ mark of the electrical box cover.	
4	Lift the electrical box cover up and remove it.	
5	Detach the clamp and disconnect the connector for the fan motor [S70].	<p>■ When reassembling, insert the clamp into the either hole as below.</p> <p>For the ferrite core of fan motor harness</p>  <p>(R17167)</p> <p>■ Some models have no ferrite core for the harness of [S70].</p>

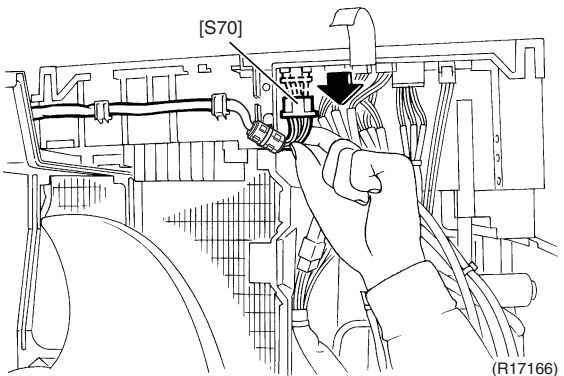
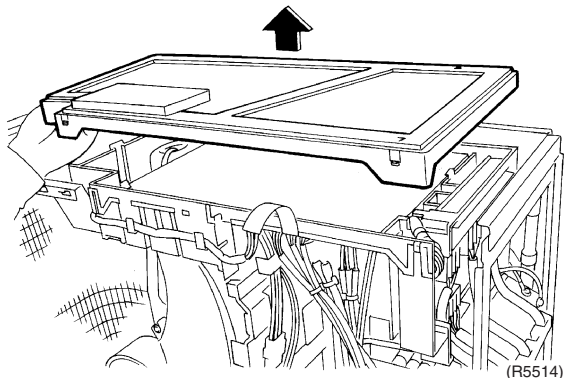
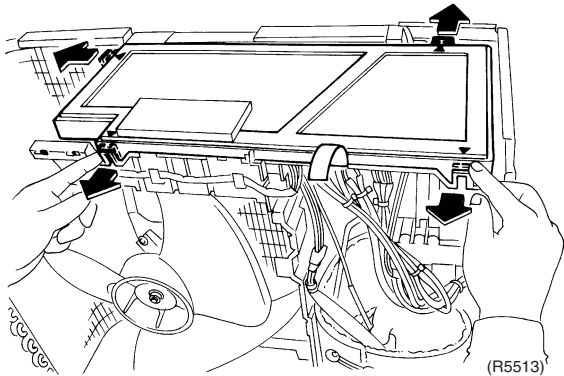
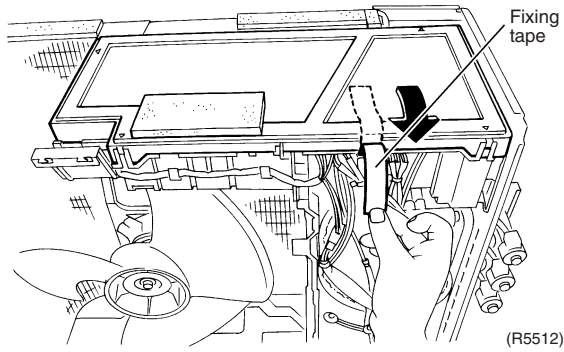

Step	Procedure	Points
6	Release the fan motor lead wire from the hooks.	
7	Disconnect the connectors for the electronic expansion valve coils.	
		<p>[S20] (white) : room A [S21] (red) : room B [S22] (blue) : room C</p> <p>■ 4-room models also have [S23] (yellow) for room D.</p>
8	Pull out the clamp.	
		<p>■ When reassembling, insert the clamp of the electronic expansion valve coil ASSY into either hole as below.</p> <div style="text-align: center;"> </div> <p>Electronic expansion valve coil (R17170)</p>

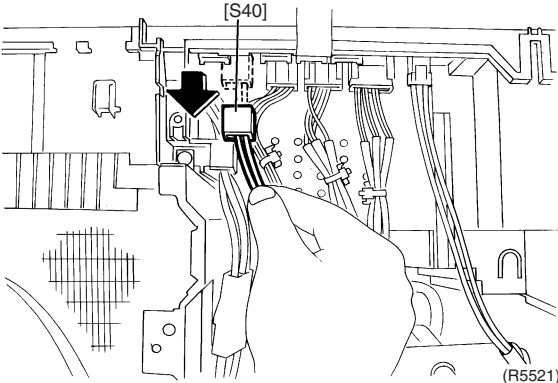
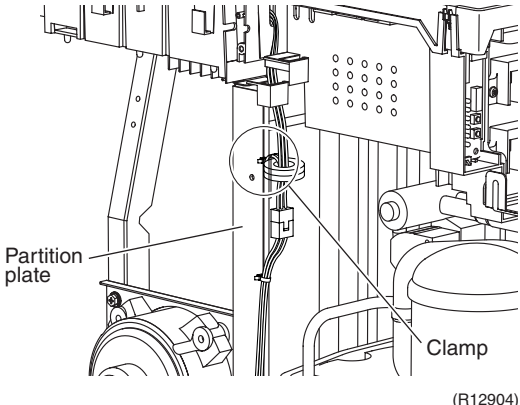
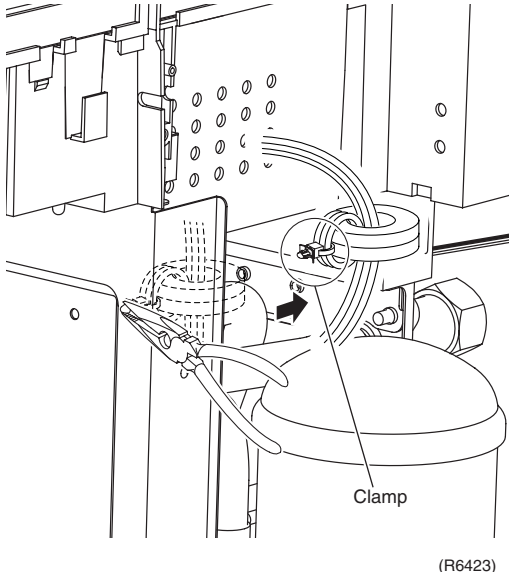
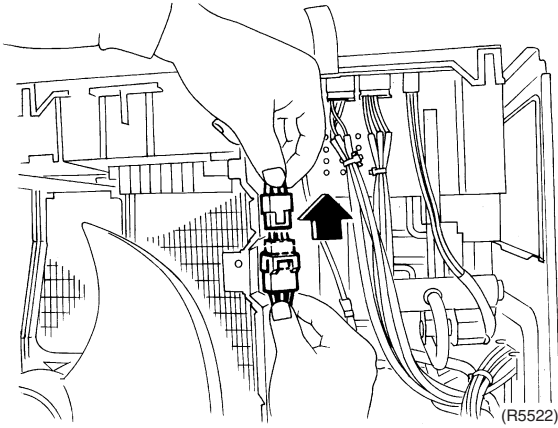
Step	Procedure	Points
9	Disconnect the connector for the overload protector [S40].	
	 <p>(R5521)</p>	
10	The wire harness for the compressor is attached to the partition plate by the clamp.	
	 <p>Partition plate</p> <p>Clamp</p> <p>(R12904)</p>	
11	Pull out the clamp with pliers.	
	 <p>Clamp</p> <p>(R6423)</p>	
12	Disconnect the relay connector of the compressor.	
	 <p>(R5522)</p>	

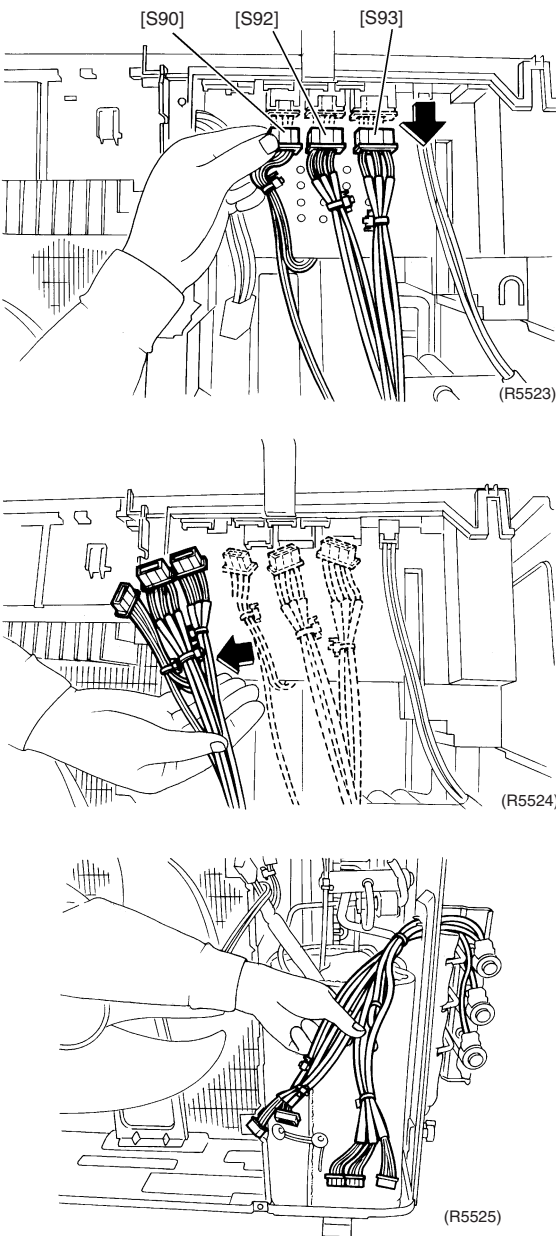
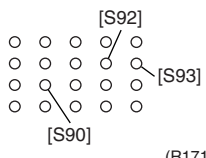
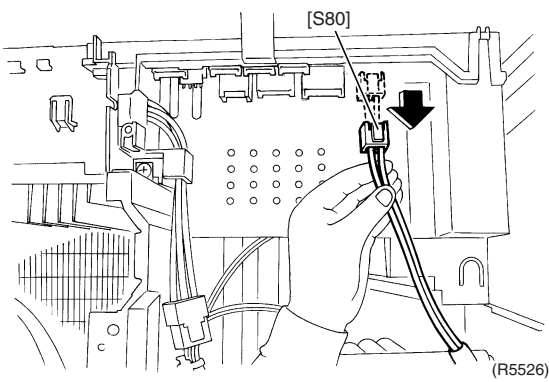
Step		Procedure	Points
13	Disconnect the each connector.		<p>[S90] : Thermistors [S92] : Gas pipe thermistors [S93] : Liquid pipe thermistors</p> <p>■ When reassembling, insert each clamp of the thermistor harnesses into the holes as below.</p>  <p>(R17169)</p>
14	Disconnect the connector for the four way valve coil [S80].		

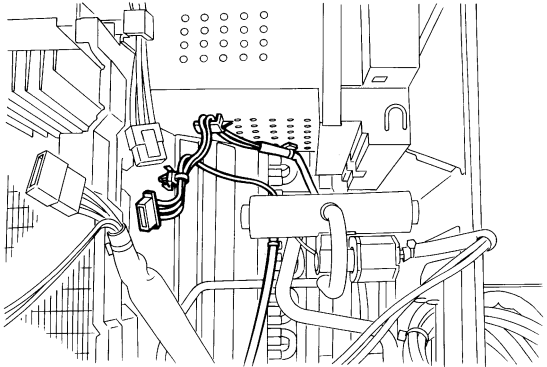
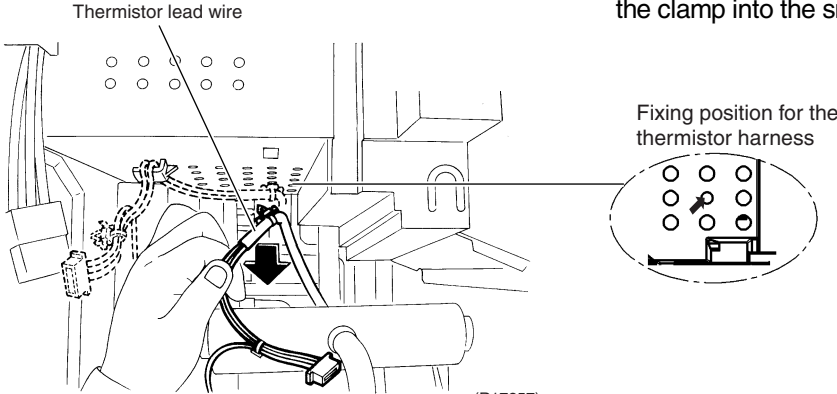
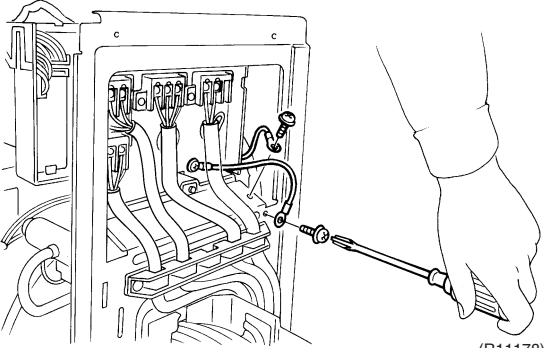
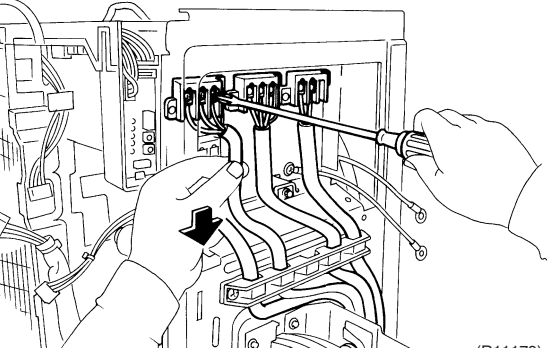
Step	Procedure	Procedure	Points
15	The figure shows the arrangement of the wire harnesses under the electrical box.	 <p>(R5527)</p>	
16	Pull out the clamp of the thermistor lead wire.	 <p>Thermistor lead wire</p> <p>Fixing position for the thermistor harness</p> <p>(R17257)</p>	<ul style="list-style-type: none"> ■ When reassembling, insert the clamp into the small hole.
2.	Remove the electrical box.	<p>1 Remove the 2 screws of the earth wires.</p>  <p>(R11178)</p> <p>2 Remove the screws on the terminal board and disconnect all the connecting wires and power supply wire.</p>  <p>(R11179)</p>	

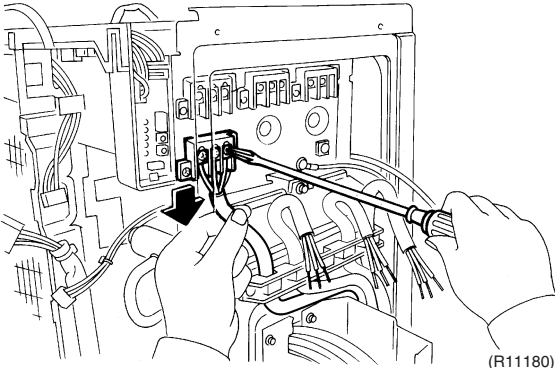
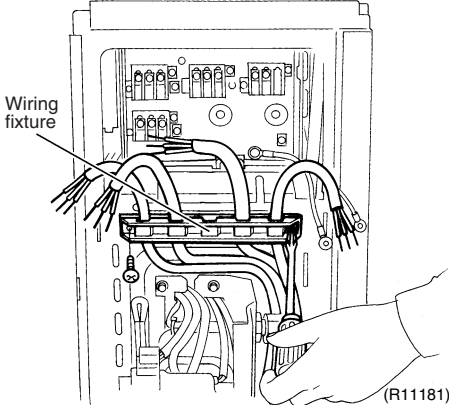
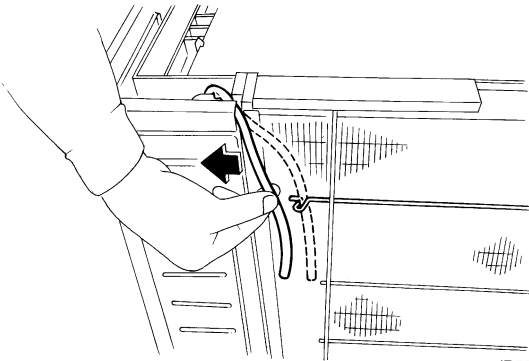
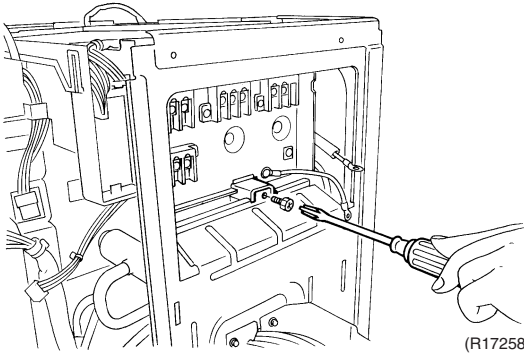
Step	Procedure	Points
3	<p>Remove the 2 screws and remove the wiring fixture.</p>  	
4	<p>Detach the outdoor temperature thermistor.</p> 	
5	<p>Remove the screw on the right side of the electrical box.</p> 	

Step	Procedure	Points
6	Remove the screw of the electrical box.	
7	Lift up and remove the electrical box.	

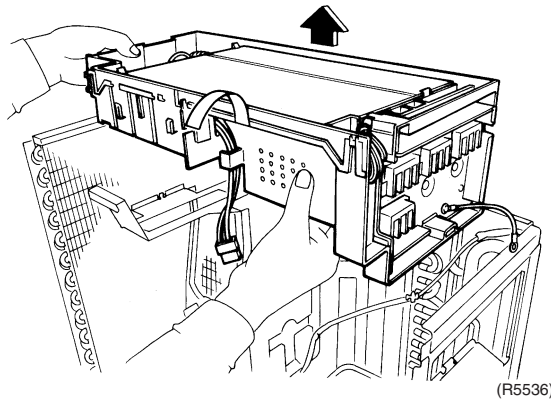
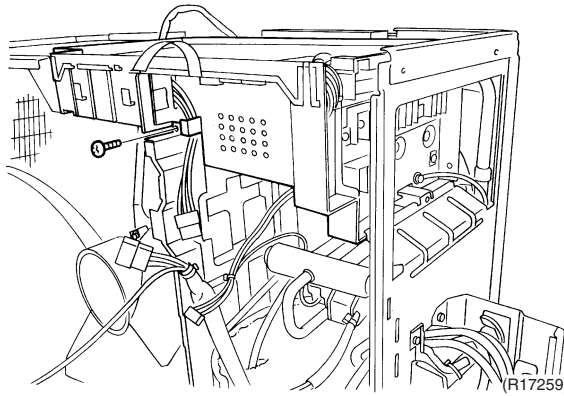

3. Removal of PCBs

Procedure



Warning

Be sure to wait for 10 minutes or more after turning off all power supplies before disassembling work.

Step	Procedure	Points
1. Remove the service monitor PCB.	<div data-bbox="528 405 1070 730"> <p>Service monitor PCB Terminal board</p> <p>(R5537)</p> </div> <div data-bbox="504 779 1062 1151"> <p>(R5538)</p> </div> <div data-bbox="509 1189 1062 1626"> <p>(R5539)</p> </div> <div data-bbox="501 1677 1062 2074"> <p>[S52] [S102]</p> <p>Service monitor PCB</p> <p>(R5540)</p> </div>	
1	External appearance	
2	Remove the screw of the terminal board and open it.	
3	Disconnect the connectors [S52] [S102] from the service monitor PCB.	

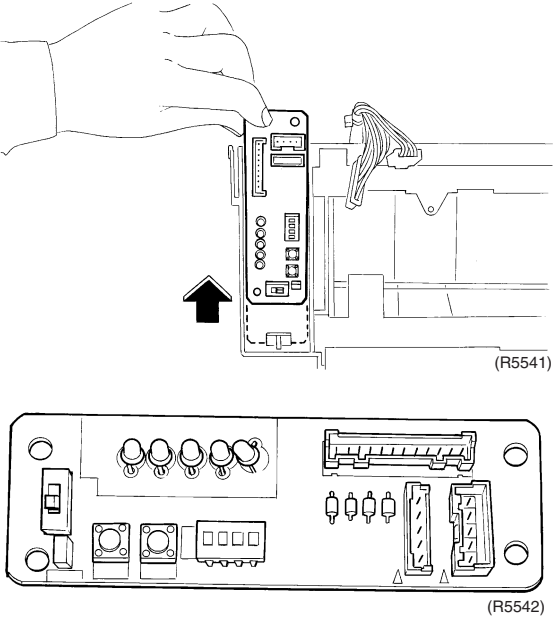
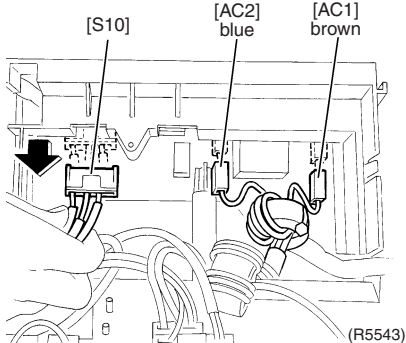
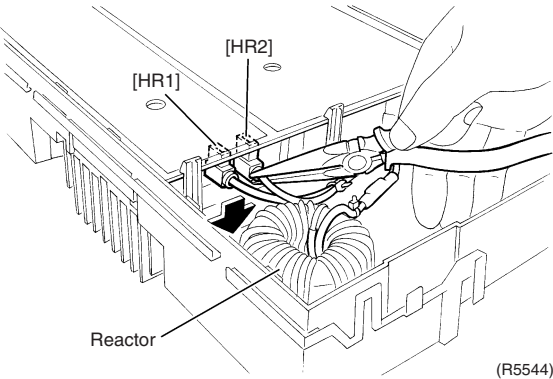
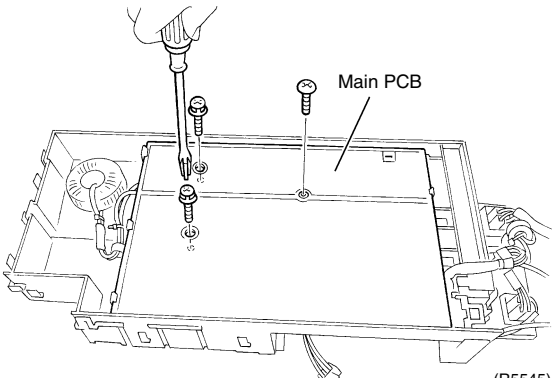
Step	Procedure	Points
<p>4</p> <p>Unfasten the upper hook and pull the service monitor PCB upward to remove.</p>		
<p>2. Remove the main PCB.</p>		
<p>1</p> <p>Disconnect the connectors for the terminal board on the right side.</p>		<p>[AC1] [AC2] : for power supply [S10] : for transmission</p>
<p>2</p> <p>Disconnect the 2 connectors for the reactor on the left side.</p>		
<p>3</p> <p>Remove the 3 screws of the main PCB.</p>		

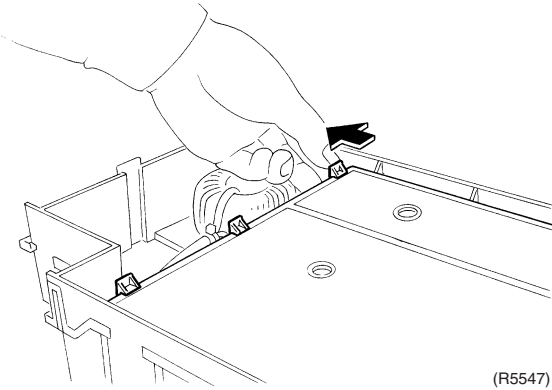
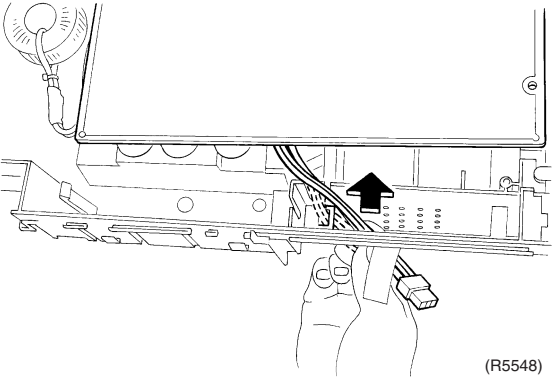
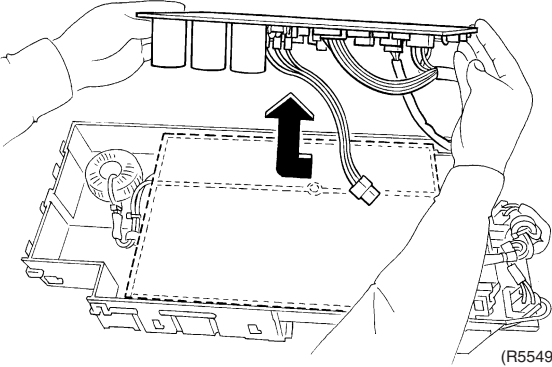
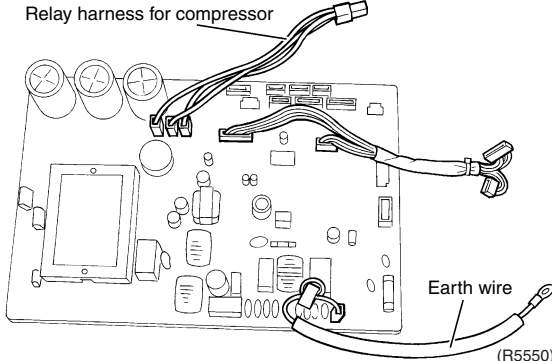
Step	Procedure	Points
4	Unfasten the 3 hooks on the reactor side and slide the main PCB to the left.	
	 <p>(R5547)</p>	
5	Release the relay harness for the compressor from the hook.	
	 <p>(R5548)</p>	
6	Lift up the main PCB and remove it.	<ul style="list-style-type: none"> ■ In working, be careful not to break the main PCB with the excessive force because the main PCB and the radiation fin are adhered to one another.
	 <p>(R5549)</p>	
	 <p>(R5550)</p>	

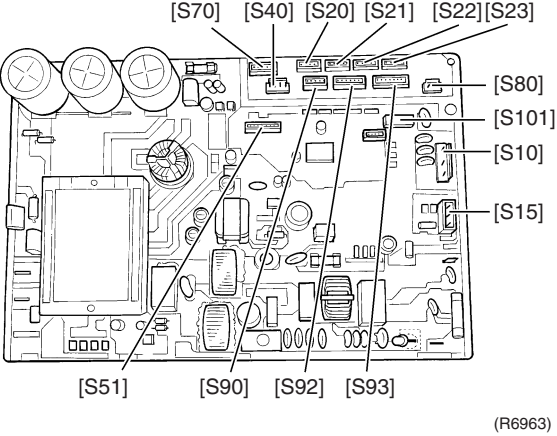
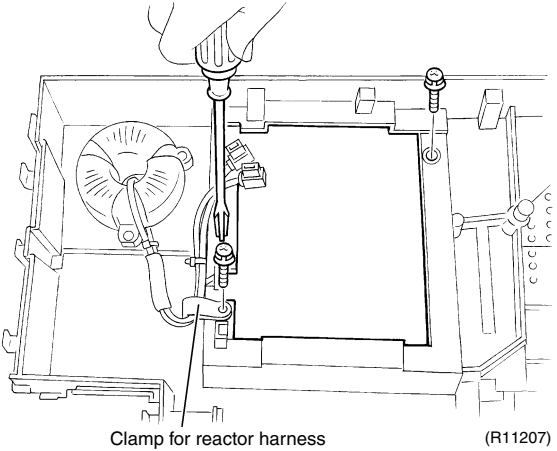
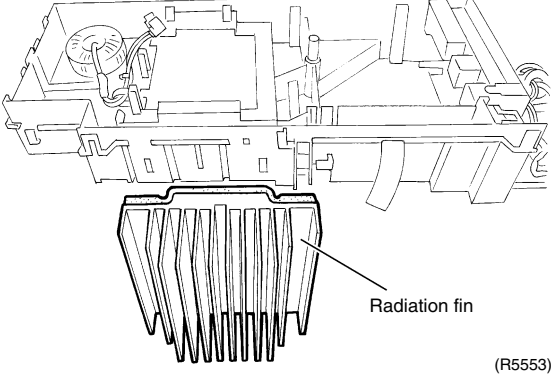
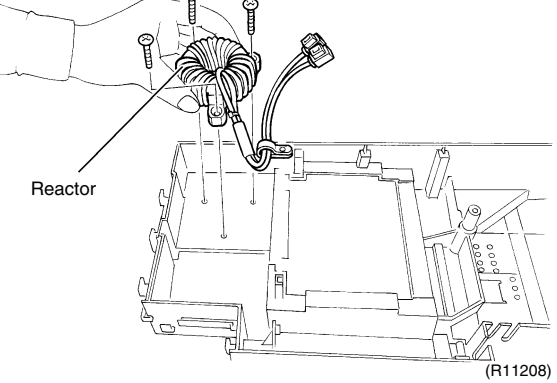
Step	Procedure	Points
7	<p>Remove the 2 screws of the radiation fin.</p>   <p>Clamp for reactor harness (R11207)</p>  <p>Radiation fin (R5553)</p>	<ul style="list-style-type: none"> ■ When reassembling, make sure to use the silicon grease. ■ Silicon grease Part No.: 1172698
8	<p>Remove the 3 screws of the reactor.</p>  <p>Reactor (R11208)</p>	

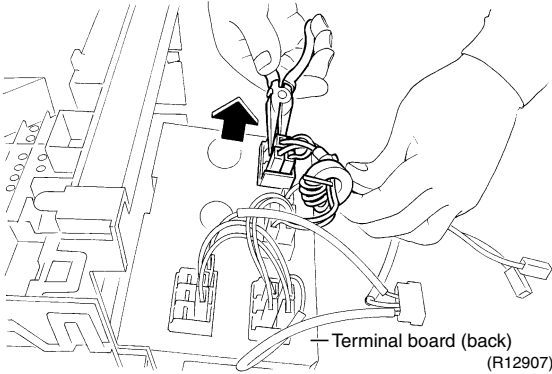
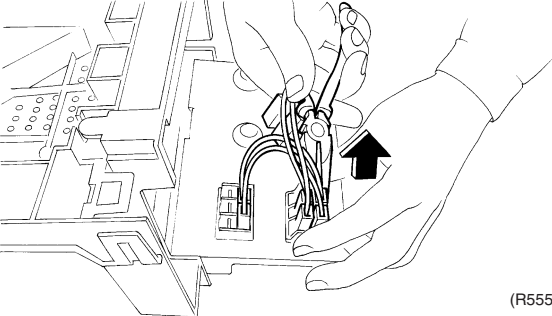
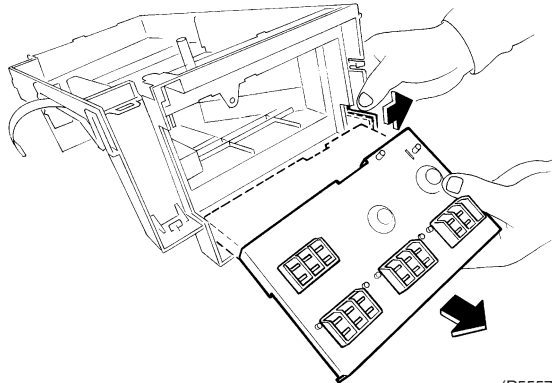
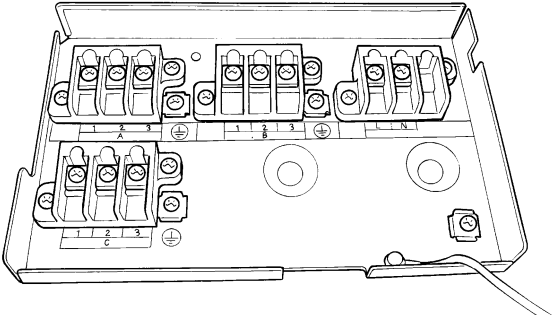
Step	Procedure	Points
<p>3. Remove the terminal board.</p>	<p>1 Disconnect all the wire harnesses from the back of the terminal board.</p>  <p>Terminal board (back) (R12907)</p>  <p>(R5556)</p> <p>2 Unfasten the hook of the electrical box and remove the terminal board.</p>  <p>(R5557)</p>  <p>(R5558)</p>	

4. Removal of Outdoor Fan / Fan Motor

Procedure



Warning

Be sure to wait for 10 minutes or more after turning off all power supplies before disassembling work.

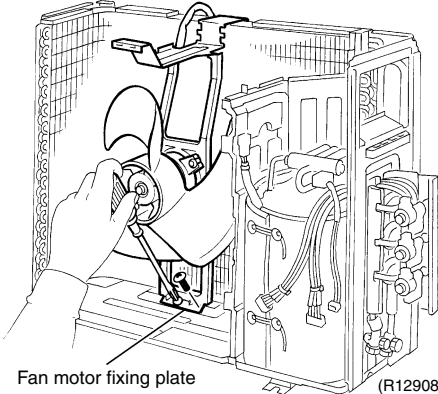
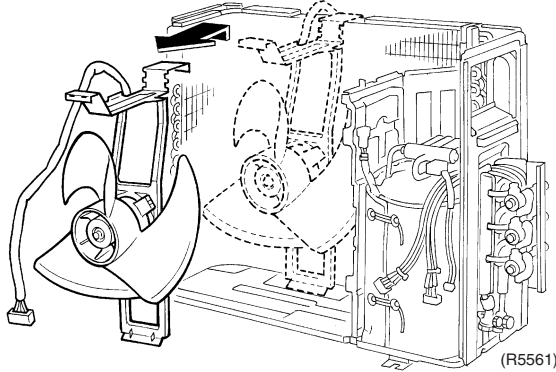
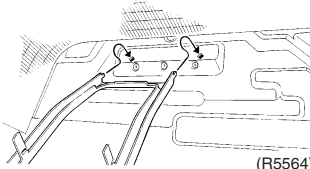
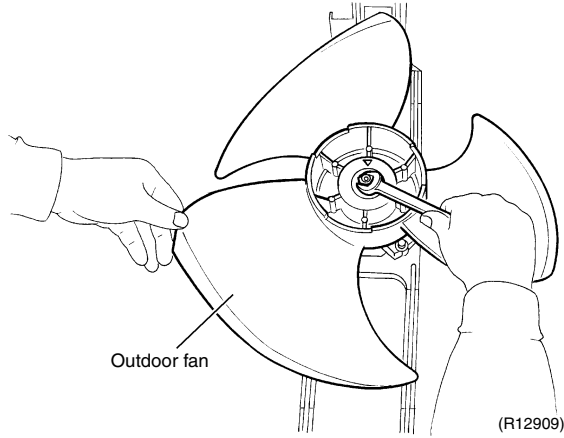
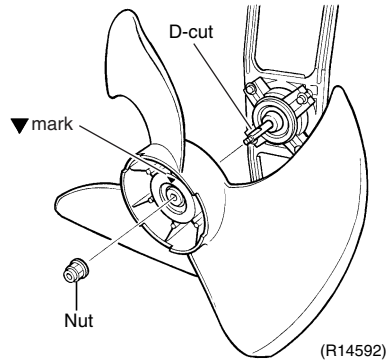
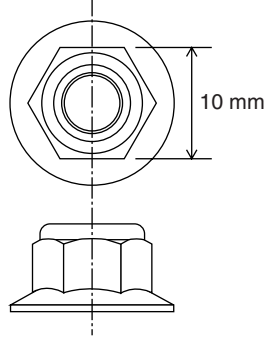
Step	Procedure	Procedure	Points
1	Remove the 2 screws of the fan motor fixing plate.	 <p>Fan motor fixing plate (R12908)</p>	<p>Preparation</p> <ul style="list-style-type: none"> Remove the outer panels and plates. Remove the electrical box.
2	Remove the fan motor fixing plate.	 <p>(R5561)</p>	 <p>(R5564)</p> <ul style="list-style-type: none"> When reassembling, fit the lower hooks.
3	Remove the nut and remove the outdoor fan.	 <p>Outdoor fan (R12909)</p>  <p>D-cut ▼ mark Nut (R14592)</p>	<p>■ Nut size: M6</p>  <p>10 mm (R12236)</p> <ul style="list-style-type: none"> When reassembling, align the ▼ mark of the outdoor fan with the D-cut section of the motor shaft.

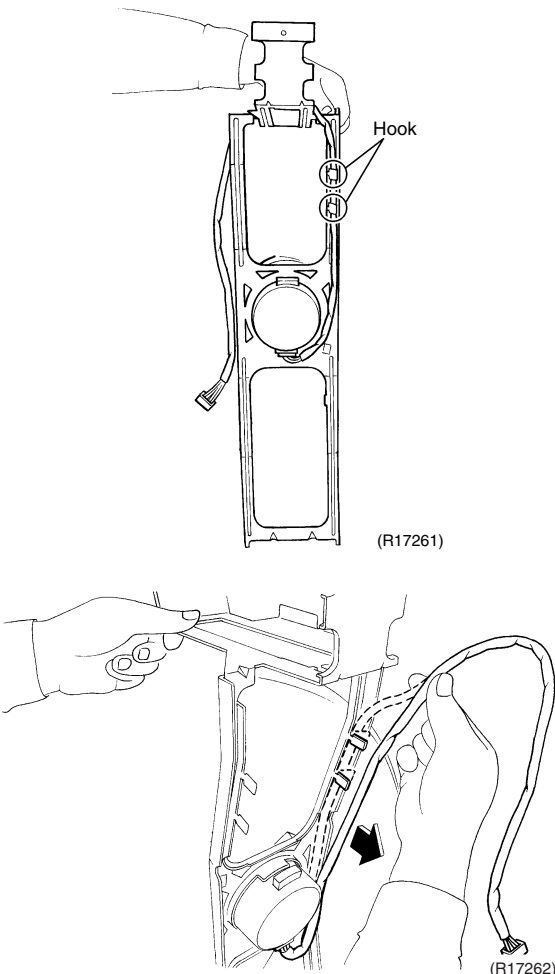
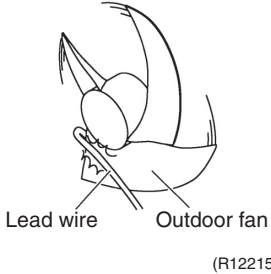
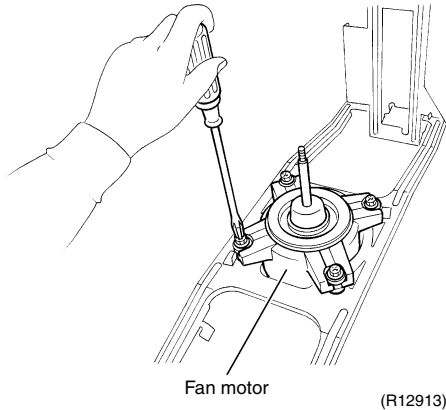
Step	Procedure	Points
4	Open the 2 hooks and release the fan motor lead wire.	<ul style="list-style-type: none"> When reassembling, put the fan motor lead wire through the back of the fan motor so as not to be entangled with the outdoor fan.
	 <p>Hook</p> <p>(R17261)</p> <p>(R17262)</p>	 <p>Lead wire</p> <p>Outdoor fan</p> <p>(R12215)</p>
5	Remove the 4 screws and remove the fan motor.	
	 <p>Fan motor</p> <p>(R12913)</p>	

5. Removal of Sound Blankets

Procedure



Warning

Be sure to wait for 10 minutes or more after turning off all power supplies before disassembling work.

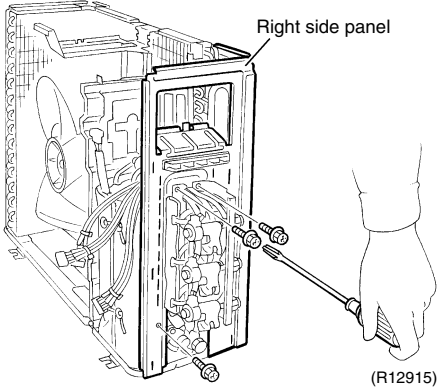
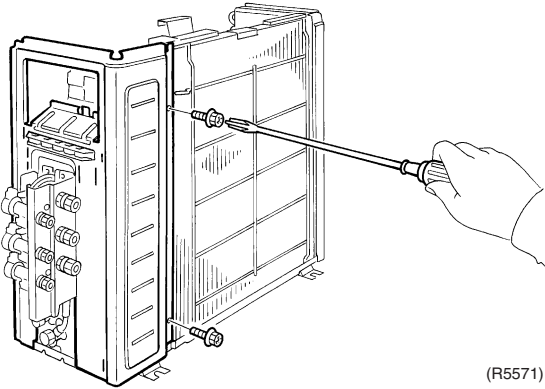
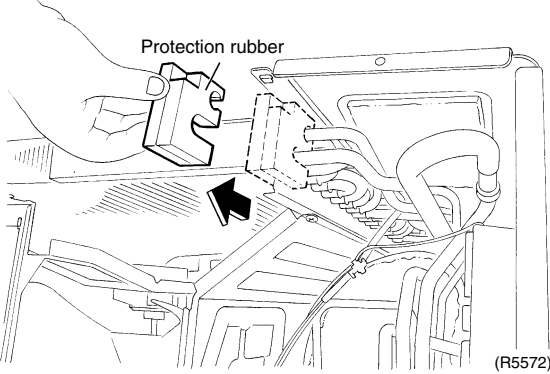
Step	Procedure	Points
1. Remove the right side panel.	 <p>Right side panel</p> <p>(R12915)</p>	<p>Preparation</p> <ul style="list-style-type: none"> ■ Remove the outer panels and plates. ■ Remove the electrical box.
1 Remove the 3 screws of the right side panel.	 <p>(R5571)</p>	
2 Remove the 2 screws on the back.	 <p>Protection rubber</p> <p>(R5572)</p>	
3 Remove the protection rubber. There is a hook on the back.		

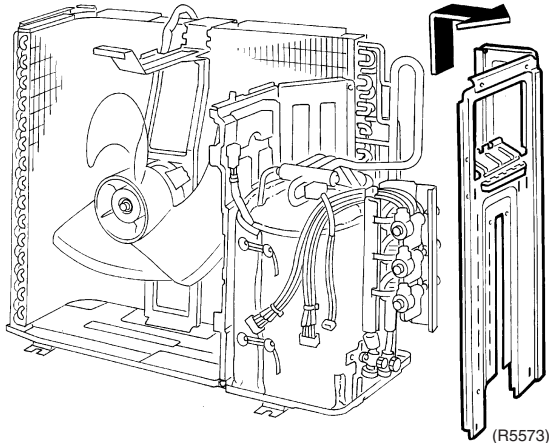
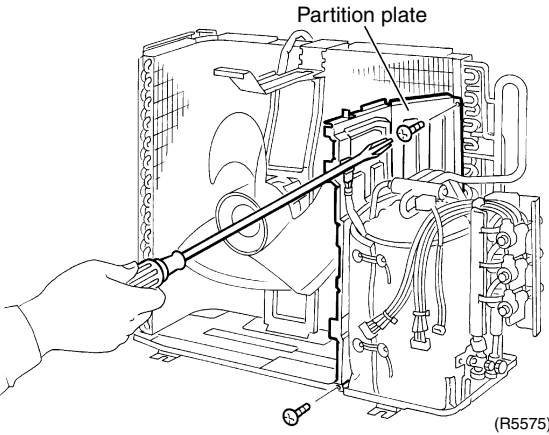
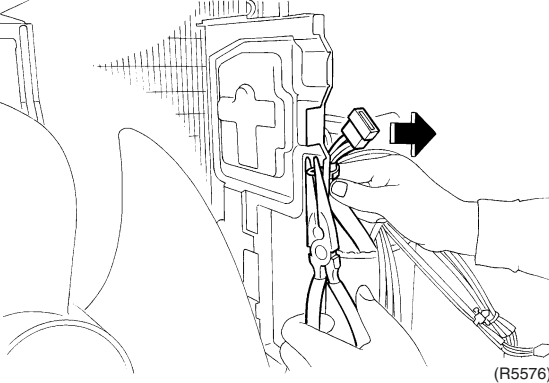
Step	Procedure	Points
4	<p>Lift up and remove the right side panel.</p> 	
2.	<p>Remove the partition plate.</p> <p>1 Remove the 2 screws of the partition plate.</p>  <p>2 Detach the clamp of the relay harness for the compressor.</p> 	

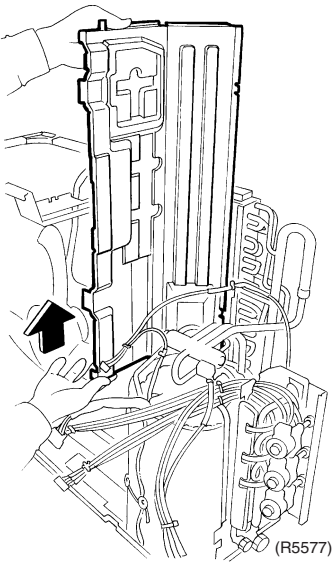
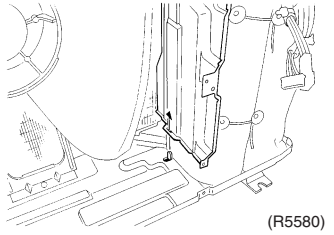
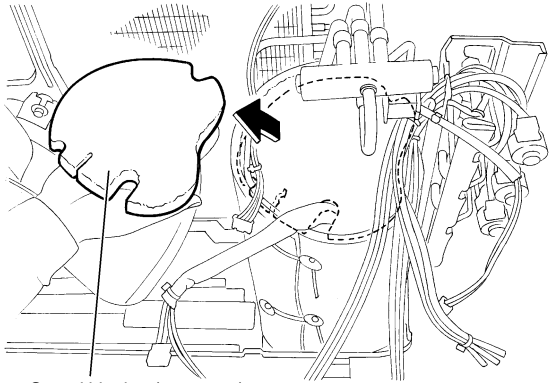
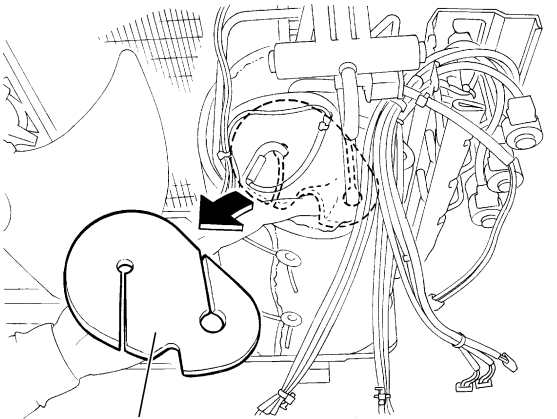
Step	Procedure	Points
3	<p>Lift up and remove the partition plate.</p> 	 <ul style="list-style-type: none"> ■ When reassembling, make sure to fit the lower hook of the partition plate.
3.	<p>Remove the sound blankets.</p>	<ul style="list-style-type: none"> ■ Since the piping ports on the sound blanket are torn easily, remove the blanket carefully. ■ The shape of the sound blankets differs depending on the model.
1	<p>Remove the sound blanket (top upper).</p>  <p style="text-align: center;">Sound blanket (top upper) (R5579)</p>	
2	<p>Remove the sound blanket (top inner).</p>  <p style="text-align: center;">Sound blanket (top inner) (R5582)</p>	

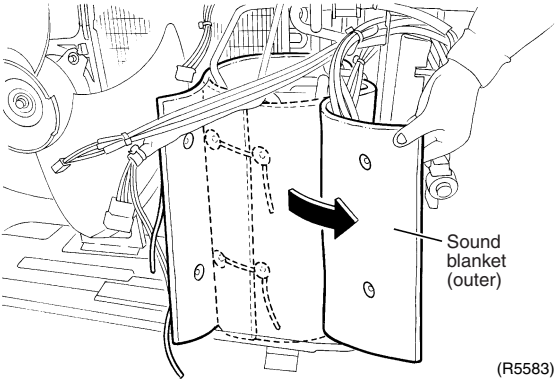
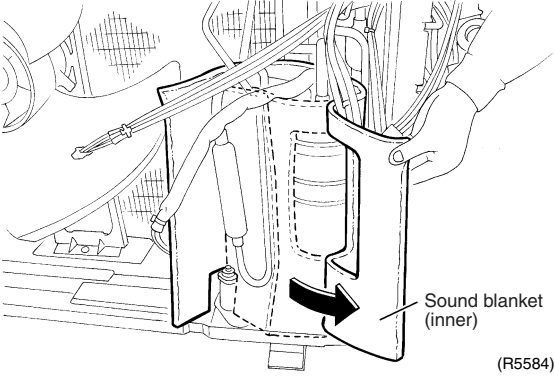
Step	Procedure	Points
3	Open the sound blanket (outer) and pull it out.	
	 <p style="text-align: right;">(R5583)</p>	
4	Open the sound blanket (inner) and pull it out.	
	 <p style="text-align: right;">(R5584)</p>	

6. Removal of Coils / Thermistors

Procedure



Warning

Be sure to wait for 10 minutes or more after turning off all power supplies before disassembling work.

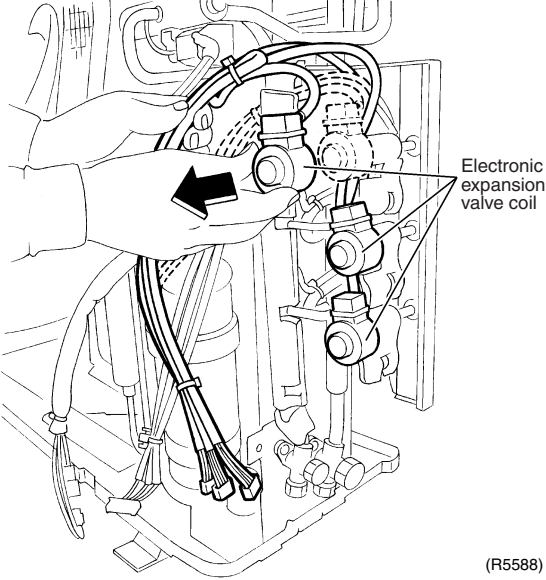
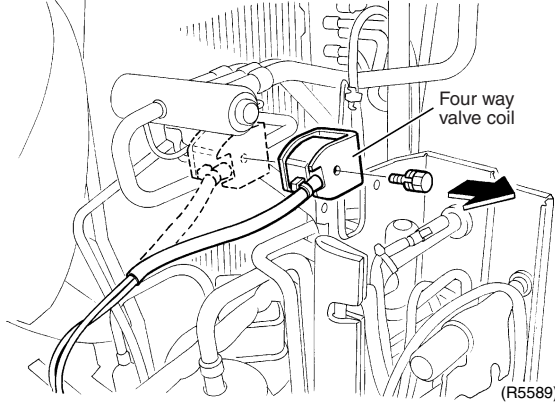
Step	Procedure	Points
1. Remove the electronic expansion valve coils. 1 Pull out the electronic expansion valve coils.	 <p style="text-align: right;">(R5588)</p>	
2. Remove the four way valve coil. 1 Remove the screw to remove the four way valve coil.	 <p style="text-align: right;">(R5589)</p>	

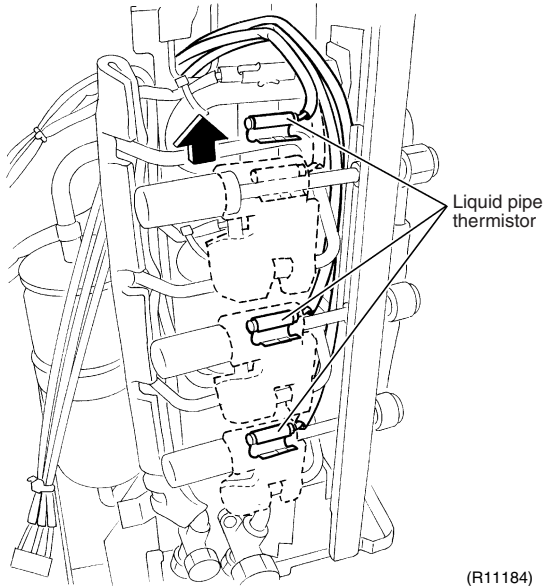
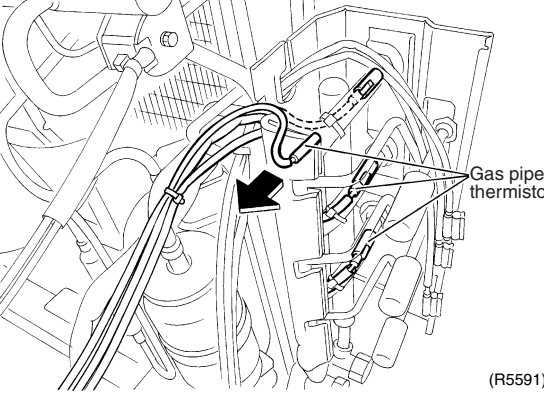
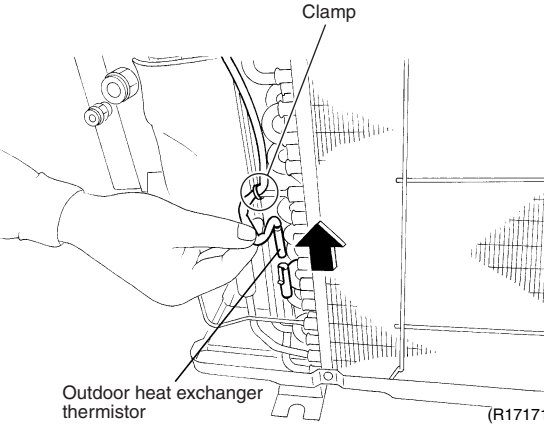
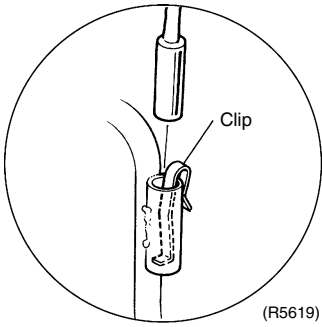
Step	Procedure	Points
<p>3. Remove the thermistors.</p>	<p>1 Open the putty and remove the liquid pipe thermistors.</p>  <p>(R11184)</p> <p>2 Pull out the gas pipe thermistors.</p>  <p>(R5591)</p> <p>3 Cut the clamp. Pull out the outdoor heat exchanger thermistor.</p>  <p>(R17171)</p>  <p>(R5619)</p>	<ul style="list-style-type: none"> ■ When reassembling, meet the edge of the thermistor and the fixture. <ul style="list-style-type: none"> ■ Be careful not to lose the clip. ■ The positions of the clamp and outdoor heat exchanger thermistor differ depending on the model.

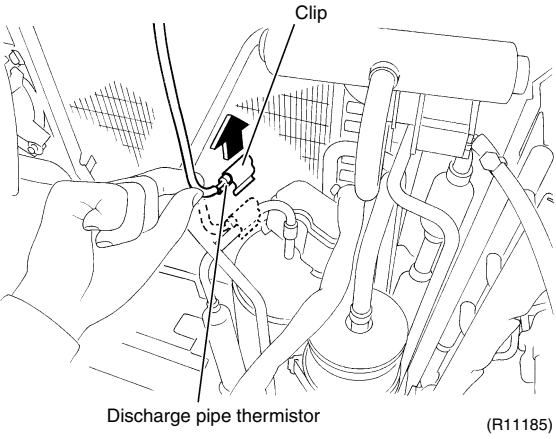
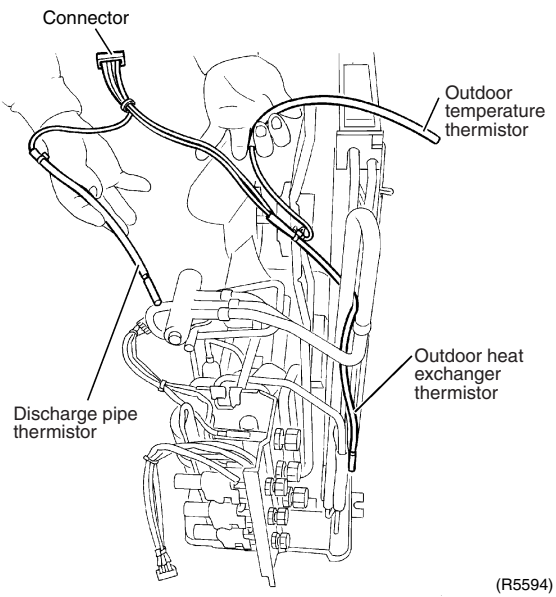
Step	Procedure	Points
4	<p>Remove the discharge pipe thermistor.</p> 	<ul style="list-style-type: none"> ■ When reassembling, meet the edge of the thermistor and the fixture.
5	<p>Remove the assembly of thermistors.</p> 	

7. Removal of Distributor

Procedure

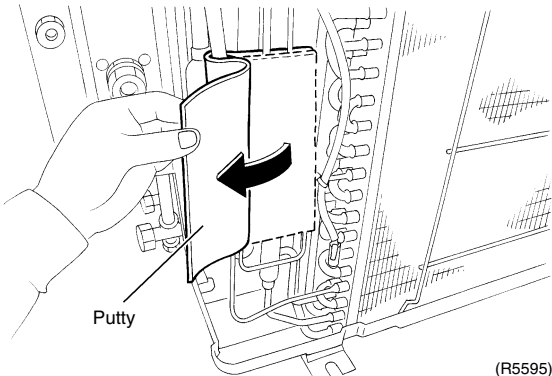
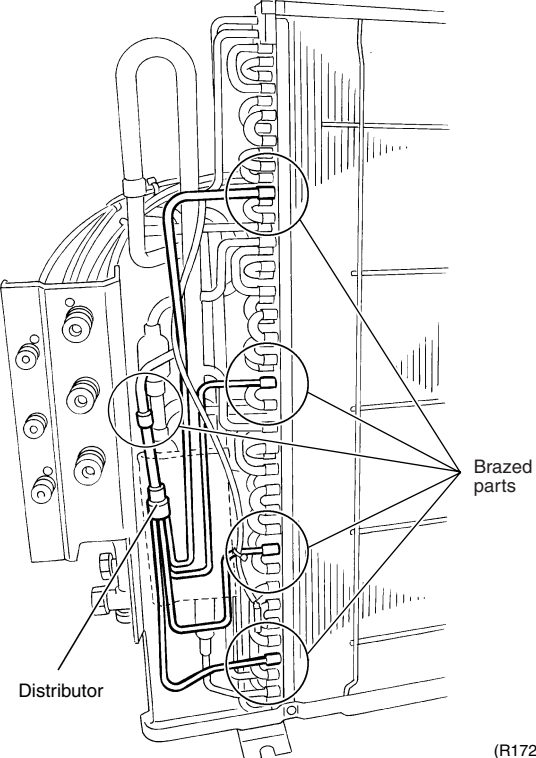

Warning Be sure to wait for 10 minutes or more after turning off all power supplies before disassembling work.

Step	Procedure	Points
1	<p>Remove the putty.</p>  <p style="text-align: right;">(R5595)</p>	<p>Warning Be careful not to get yourself burnt with the pipes and other parts that are heated by the gas brazing machine.</p> <p>Warning If the refrigerant gas leaks during work, ventilate the room. (If the refrigerant gas is exposed to flames, toxic gas may be generated.)</p> <p>Caution From the viewpoint of global environment protection, do not discharge the refrigerant gas in the atmosphere. Make sure to collect all the refrigerant gas.</p>
<ul style="list-style-type: none"> ■ Before working, make sure that the refrigerant gas is empty in the circuit. ■ Be sure to apply nitrogen replacement when heating up the brazed part. 	 <p style="text-align: right;">(R17263)</p>	<p>Cautions for restoration</p> <ol style="list-style-type: none"> 1. Restore the piping by non-oxidation brazing. 2. It is required to prevent the carbonization of the oil inside the four way valve and the deterioration of the gaskets affected by heat. (Keep below 120°C.) For the sake of this, wrap the four way valve with wet cloth and provide water so that the cloth does not dry.
<p>Note:</p> <ul style="list-style-type: none"> ■ Do not use a metal saw for cutting pipes by all means because the sawdust comes into the circuit. ■ When withdrawing the pipes, be careful not to pinch them firmly with pliers. The pipes may get deformed. ■ Provide a protective sheet or a steel plate so that the brazing flame cannot influence peripheries. 		<p>In case of difficulty with gas brazing machine</p> <ol style="list-style-type: none"> 1. Disconnect the brazed part where is easy to disconnect and restore. 2. Cut pipes on the main unit with a tube cutter in order to make it easy to disconnect.

8. Removal of Four Way Valve

Procedure



Warning

Be sure to wait for 10 minutes or more after turning off all power supplies before disassembling work.

Step	Procedure	Points
<ul style="list-style-type: none"> ■ Before working, make sure that the refrigerant gas is empty in the circuit. ■ Be sure to apply nitrogen replacement when heating up the brazed part. 	<p style="text-align: right;">Four way valve coil (R5589)</p>	<ul style="list-style-type: none"> ■ The cooling only models have no four way valve coil. <p>Warning Be careful not to get yourself burnt with the pipes and other parts that are heated by the gas brazing machine.</p>
1	Remove the screw to remove the four way valve coil.	<p>Warning If the refrigerant gas leaks during work, ventilate the room. (If the refrigerant gas is exposed to flames, toxic gas may be generated.)</p>
2	Heat up the 4 brazed part of the four way valve. First, disconnect the part (a).	<p>Caution From the viewpoint of global environment protection, do not discharge the refrigerant gas in the atmosphere. Make sure to collect all the refrigerant gas.</p>
3	Disconnect the part (b).	<p>Cautions for restoration</p> <ol style="list-style-type: none"> 1. Restore the piping by non-oxidation brazing. 2. It is required to prevent the carbonization of the oil inside the four way valve and the deterioration of the gaskets affected by heat. (Keep below 120°C.) For the sake of this, wrap the four way valve with wet cloth and provide water so that the cloth does not dry.
4	Disconnect the part (c) and (d) and remove the four way valve.	<p>In case of difficulty with gas brazing machine</p> <ol style="list-style-type: none"> 1. Disconnect the brazed part where is easy to disconnect and restore. 2. Cut pipes on the main unit with a tube cutter in order to make it easy to disconnect.
<p>Note:</p> <ul style="list-style-type: none"> ■ Do not use a metal saw for cutting pipes by all means because the sawdust comes into the circuit. ■ When withdrawing the pipes, be careful not to pinch them firmly with pliers. The pipes may get deformed. ■ Provide a protective sheet or a steel plate so that the brazing flame cannot influence peripheries. 		<p style="text-align: right;">(R14067)</p> <p style="text-align: right;">(R14068)</p> <p style="text-align: right;">(R14069)</p>

9. Removal of Compressor

Procedure



Warning

Be sure to wait for 10 minutes or more after turning off all power supplies before disassembling work.

Step	Procedure	Points
1	Remove the terminal cover.	
2	Disconnect the compressor lead wires.	
3	Detach the overload protector.	

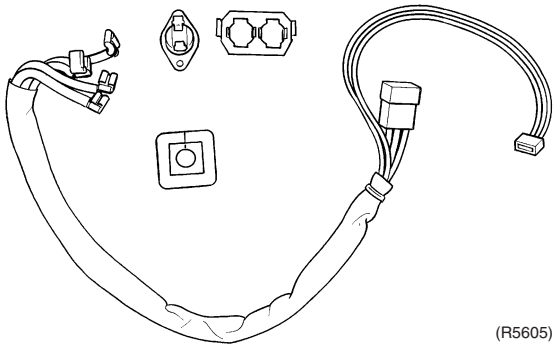
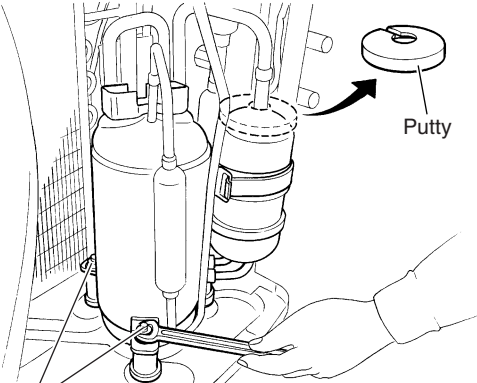
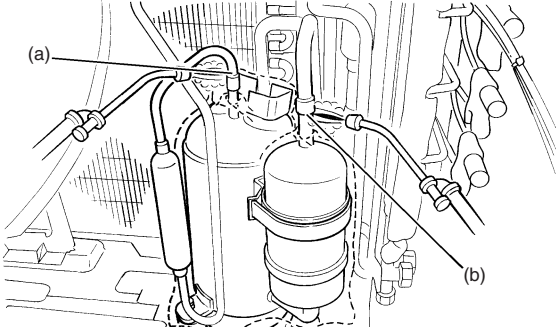
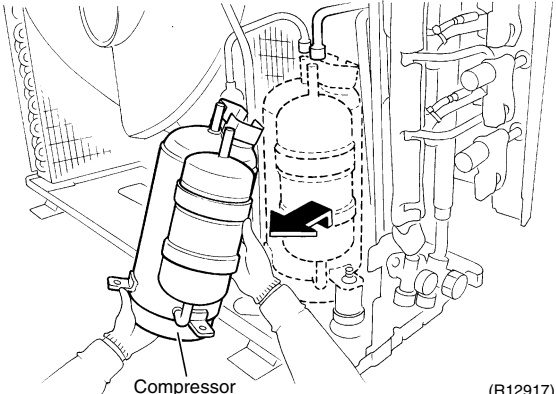
Step	Procedure	Points
4 Remove the putty. 5 Remove the 2 nuts.	 <p style="text-align: right;">(R5605)</p>	<p>Warning Be careful not to get yourself burnt with the pipes and other parts that are heated by the gas brazing machine.</p> <p>Warning If the refrigerant gas leaks during work, ventilate the room. (If the refrigerant gas is exposed to flames, toxic gas may be generated.)</p> <p>Warning Since it may happen that the refrigerant oil in the compressor catches fire, prepare wet cloth so as to extinguish fire immediately.</p>
<ul style="list-style-type: none"> ■ Before working, make sure that the refrigerant gas is empty in the circuit. ■ Be sure to apply nitrogen replacement when heating up the brazed part. 	 <p style="text-align: right;">(R17172)</p>	<p>Caution From the viewpoint of global environment protection, do not discharge the refrigerant gas in the atmosphere. Make sure to collect all the refrigerant gas.</p>
6 Heat up the brazed part of the discharge side and disconnect the part (a). 7 Heat up the brazed part of the suction side and disconnect the part (b). 8 Remove the compressor.	 <p style="text-align: right;">(R14070)</p>	<p>Cautions for restoration</p> <ol style="list-style-type: none"> 1. Restore the piping by non-oxidation brazing. 2. It is required to prevent the carbonization of the oil inside the four way valve and the deterioration of the gaskets affected by heat. (Keep below 120°C.) For the sake of this, wrap the four way valve with wet cloth and provide water so that the cloth does not dry.
<p>Note:</p> <ul style="list-style-type: none"> ■ Do not use a metal saw for cutting pipes by all means because the sawdust comes into the circuit. ■ When withdrawing the pipes, be careful not to pinch them firmly with pliers. The pipes may get deformed. ■ Provide a protective sheet or a steel plate so that the brazing flame cannot influence peripheries. ■ Be careful so as not to burn the compressor terminals, the name plate, the heat exchanger fin. 	 <p style="text-align: right;">(R12917)</p>	<p>In case of difficulty with gas brazing machine</p> <ol style="list-style-type: none"> 1. Disconnect the brazed part where is easy to disconnect and restore. 2. Cut pipes on the main unit with a tube cutter in order to make it easy to disconnect.

Revision History

Month / Year	Version	Revised contents
01 / 2013	Si121092	First edition

Warning



- Daikin products are manufactured for export to numerous countries throughout the world. Prior to purchase, please confirm with your local authorised importer, distributor and/or retailer whether this product conforms to the applicable standards, and is suitable for use, in the region where the product will be used. This statement does not purport to exclude, restrict or modify the application of any local legislation.
- Ask a qualified installer or contractor to install this product. Do not try to install the product yourself. Improper installation can result in water or refrigerant leakage, electrical shock, fire or explosion.
- Use only those parts and accessories supplied or specified by Daikin. Ask a qualified installer or contractor to install those parts and accessories. Use of unauthorised parts and accessories or improper installation of parts and accessories can result in water or refrigerant leakage, electrical shock, fire or explosion.
- Read the User's Manual carefully before using this product. The User's Manual provides important safety instructions and warnings. Be sure to follow these instructions and warnings.

If you have any enquiries, please contact your local importer, distributor and/or retailer.

Cautions on product corrosion

1. Air conditioners should not be installed in areas where corrosive gases, such as acid gas or alkaline gas, are produced.
2. If the outdoor unit is to be installed close to the sea shore, direct exposure to the sea breeze should be avoided. If you need to install the outdoor unit close to the sea shore, contact your local distributor.

Dealer

DAIKIN INDUSTRIES, LTD.

Head Office:
Umeda Center Bldg., 2-4-12, Nakazaki-Nishi,
Kita-ku, Osaka, 530-8323 Japan

Tokyo Office:
JR Shinagawa East Bldg., 2-18-1, Konan,
Minato-ku, Tokyo, 108-0075 Japan

http://www.daikin.com/global_ac/

©All rights reserved