





Si04-958

# REMOVAL PROCEDURE



S E R V I C E M A N U A L

## 7.1/8.0/9.0/10.0 kW Class 30000/36000 Btu/h Class

-  Indoor Unit
-  Inverter
-  Wall Mounted Type



# **Service Manual Removal Procedure**

## **Indoor Unit**

●Cooling Only  
FTKS71HVMG

●Heat Pump  
FTXS30HVJU  
FTXS36HVJU

FTXS80HVMA  
FTXS90HVMA  
FTXS100HVMA

FTXS90JVMA  
FTXS100JVMA

# Table of Contents

1. Removal of Air Filters / Front Panel .....	2
2. Removal of Front Grille .....	5
3. Removal of Electrical Box .....	8
4. Removal of PCBs.....	12
5. Removal of Horizontal Blades / Swing Motors .....	20
6. Removal of Fan Motor.....	28
7. Removal of Indoor Heat Exchanger .....	31
8. Removal of Fan Rotor .....	34
9. Removal of Vertical Blade ASSY .....	36



**Note:** ♦ The illustrations may be slightly different depending on the model.

# 1. Removal of Air Filters / Front Panel

**Procedure**



**Warning** Be sure to wait for 10 minutes or more after turning off all power supplies before disassembling work.

Step	Procedure	Points
<p>1. Appearance features</p>		<p><b>Warning</b>  <b>Dangerous: High voltage</b>                  A high voltage is applied to all the electric circuits of this product including thermistors.</p> <ul style="list-style-type: none"> <li>■ When the signal receiver catches a signal from the remote controller, the receiving tone sounds and the operation lamp blinks immediately to confirm the signal reception.</li> <li>■ When the [ON/OFF] button is kept pressed for 5 seconds, the forced cooling operation is performed for about 15 minutes.</li> </ul>
<p>2. Remove the air filters.</p> <p>1 Open the front panel to the position where it stops.</p> <p>2 Slightly push up the center knob of the air filter and unfasten the hooks.</p> <p>3 Pull out the air filter downward and remove it.</p>		<ul style="list-style-type: none"> <li>■ The 3 filters are interchangeable.</li> <li>■ Insert the air filter with the "FRONT" mark faced up.</li> <li>■ The air filter can be set easily by inserting it along the guides.</li> <li>■ Be sure to insert the hooks (at 2 lower positions) when reassembling the air filter.</li> </ul>

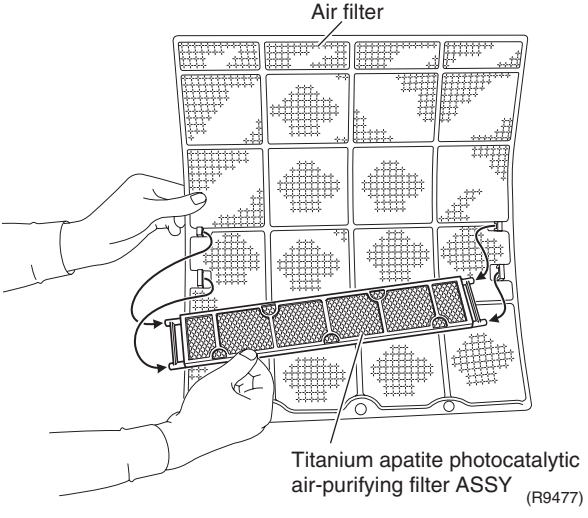
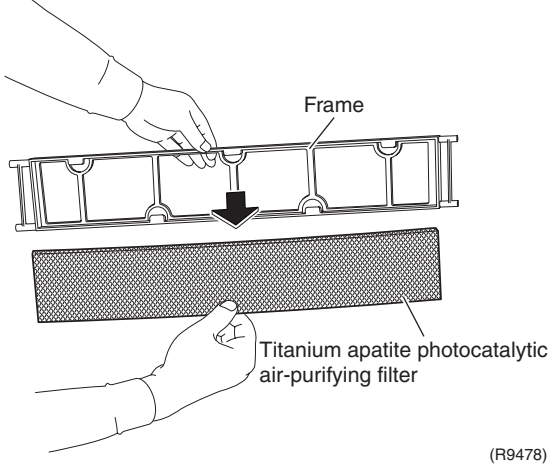
Step	Procedure	Points
3.	Remove the Titanium apatite photocatalytic air-purifying filters.	
1	<p>Remove the Titanium apatite photocatalytic air-purifying filter ASSY by unfastening the projections from the back of the air filter frame.</p> 	<ul style="list-style-type: none"> <li>■ The 3 filters are interchangeable.</li> </ul>
2	<p>Remove the Titanium apatite photocatalytic air-purifying filter from its frame.</p> 	

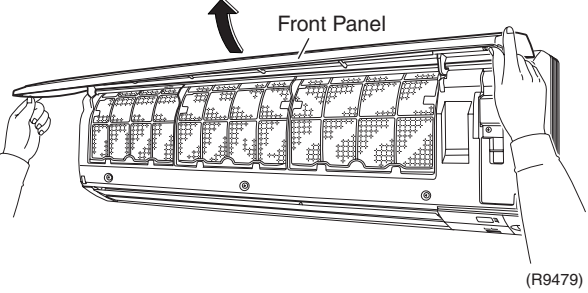
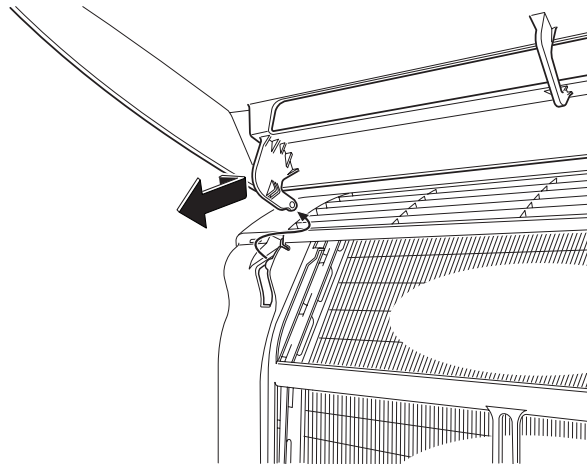
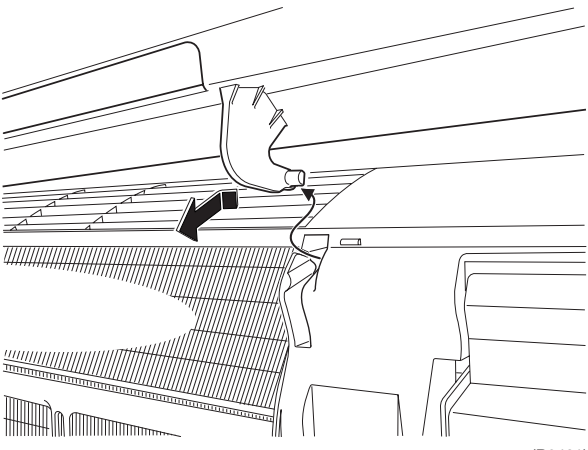
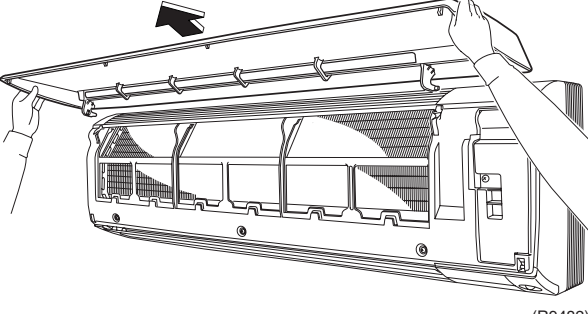
Step	Procedure	Points
<p>4. Remove the front panel.</p> <p>1</p>	<p>While opening the front panel further than it stops, release both the shafts.</p>  <p>(R9479)</p>  <p>(R9480)</p>  <p>(R9481)</p>	<ul style="list-style-type: none"> <li>■ Slide the front panel from side to side to release each shaft.</li> <li>■ When reassembling the front panel, fit the right and left rotary shafts one by one into the grooves and fully push them into position.</li> </ul>
<p>2</p>	<p>Remove the front panel.</p>  <p>(R9482)</p>	

## 2. Removal of Front Grille

### Procedure

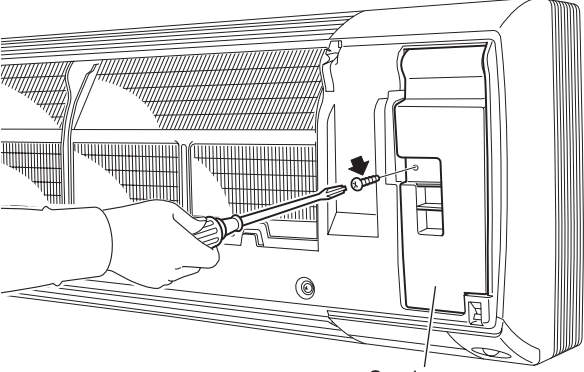
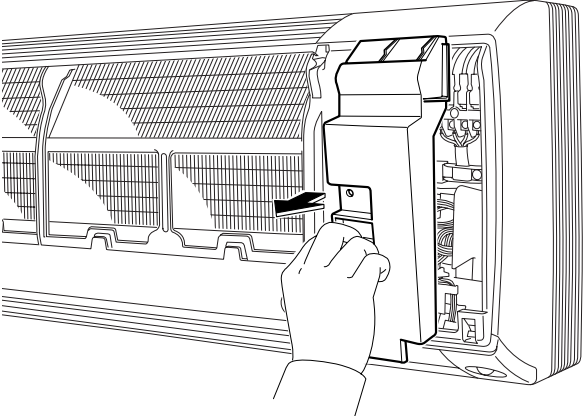
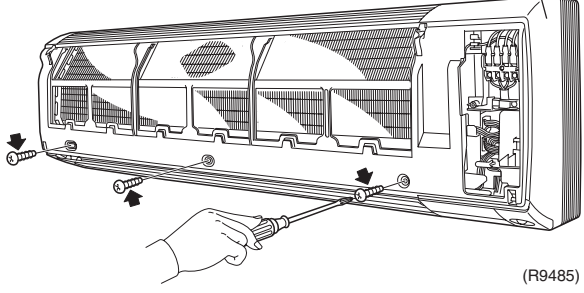
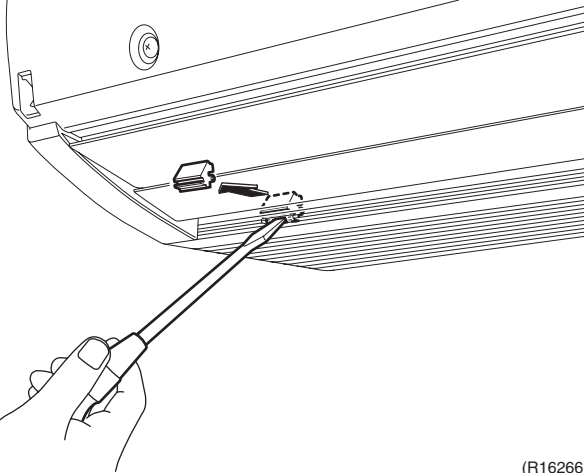

**Warning** Be sure to wait for 10 minutes or more after turning off all power supplies before disassembling work.

Step	Procedure	Points
1. Remove the service cover.  1 Remove the screw and remove the service cover.	 <p style="text-align: right;">Service cover (R9483)</p>  <p style="text-align: right;">(R9484)</p>	<ul style="list-style-type: none"> <li>■ You can remove the front grille without detaching the service cover.</li> </ul>
2. Remove the front grille.  1 Remove the 3 screws of the front grille.  2 Remove the 3 screw covers with a flat screwdriver.	 <p style="text-align: right;">Front grille (R9485)</p>  <p style="text-align: right;">(R16266)</p>	<ul style="list-style-type: none"> <li>■ Refer to the removal procedure in a reverse way when reassembling.</li> </ul>

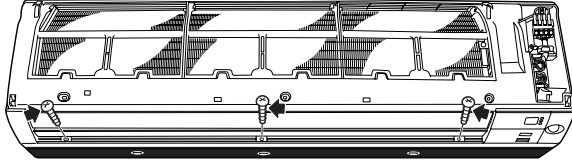
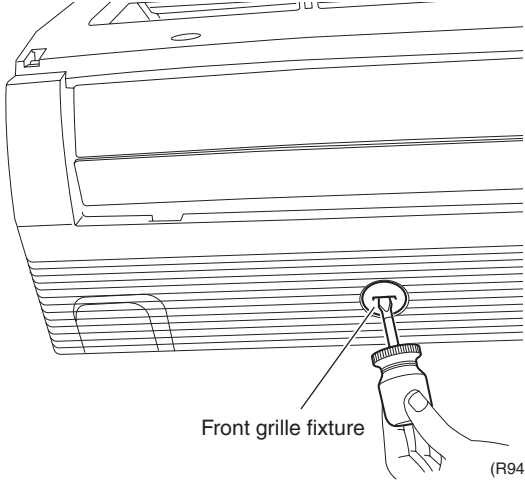
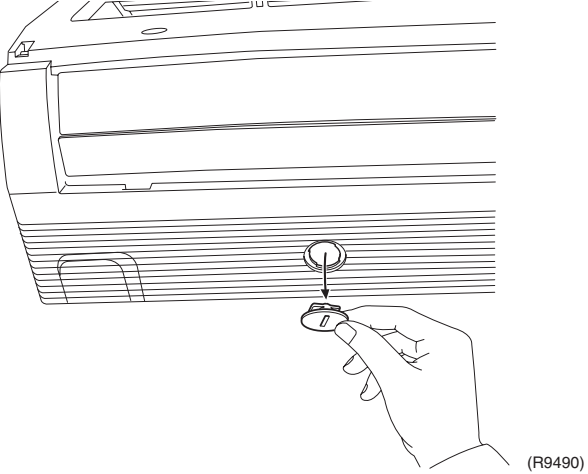
Step	Procedure	Points
3	<p>Remove the lower 3 screws.</p>  <p>(R9488)</p>	
4	<p>Remove the 3 front grille fixtures.</p>  <p>Front grille fixture</p> <p>(R9489)</p>  <p>(R9490)</p>	<p>■ The Illustration shows the left fixture.</p>



Step	Procedure	Points
5	Unfasten the 4 hooks on the top of the front grille.	<ul style="list-style-type: none"> <li>■ The convex marks (...) on the front panel indicate the position of the hooks.</li> </ul>
6	Pull the upper part of the front grille out and lift the lower part up, and then remove the front grille.	<ul style="list-style-type: none"> <li>■ When reassembling, make sure that all the 4 hooks are fastened as they were.</li> </ul>

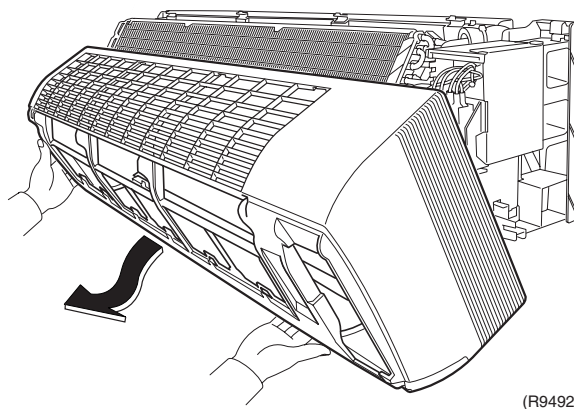
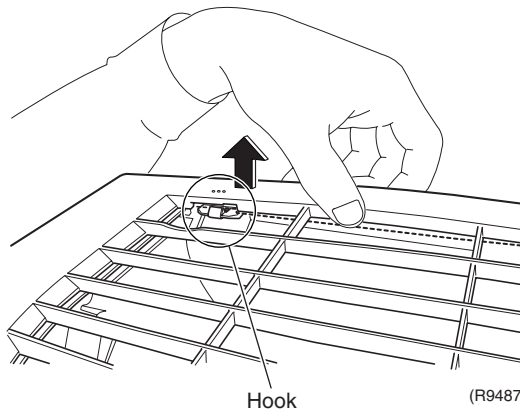
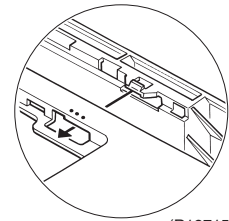
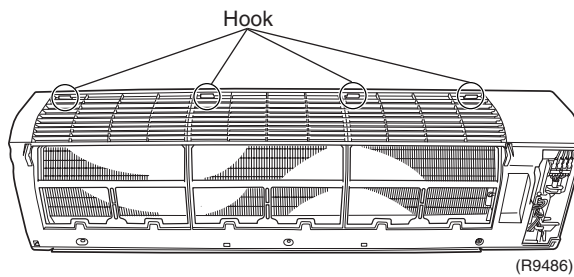

### 3. Removal of Electrical Box

**Procedure**



**Warning** Be sure to wait for 10 minutes or more after turning off all power supplies before disassembling work.

Step	Procedure	Points
1. Layout of the parts	<p style="text-align: right;">(R9493)</p>	<p><b>Preparation</b></p> <ul style="list-style-type: none"> <li>Remove the front grille according to the “Removal of Front Grille.”</li> </ul>
2. Remove the drip proof plate.	<p style="text-align: center;">Drip proof plate (R9494)</p>	<ul style="list-style-type: none"> <li>The shape of the drip proof plate differs by the model.</li> </ul>
1 Remove the screw.  2 Remove the drip proof plate from the indoor heat exchanger.	<p style="text-align: right;">(R9496)</p>	<p style="text-align: right;">(R9495)</p> <ul style="list-style-type: none"> <li>When reassembling, fit the hook to the indoor heat exchanger.</li> </ul>

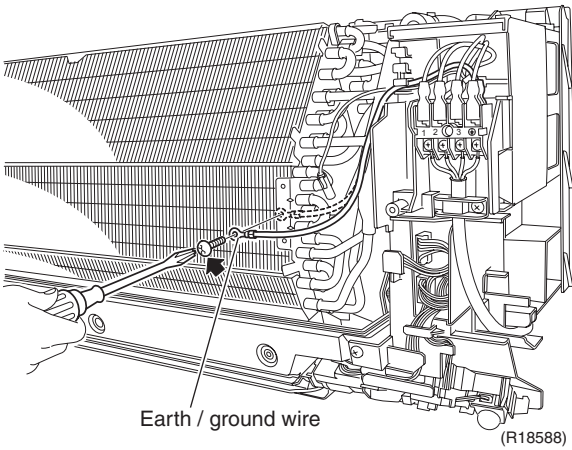
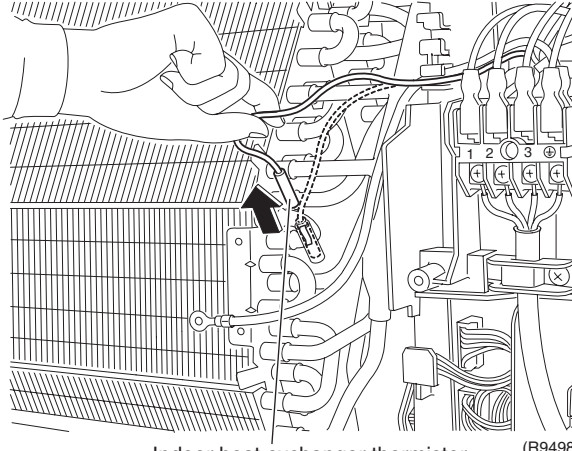
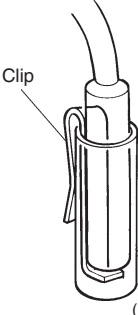
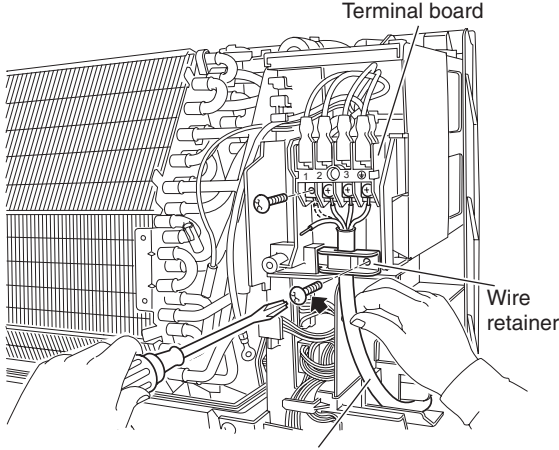
Step	Procedure	Points
3. Release the earth / ground wire and the indoor heat exchanger thermistor.		
1 Remove the screw and release the earth / ground wire.	 <p>Earth / ground wire (R18588)</p>	
2 Pull out the indoor heat exchanger thermistor.	 <p>Indoor heat exchanger thermistor (R9498)</p>	<ul style="list-style-type: none"> <li>■ The position of the indoor heat exchanger thermistor is slightly different depending on the model.</li> <li>■ Be careful not to lose the clip of the thermistor.</li> </ul>  <p>Clip (R11268)</p>
4. Remove the electrical box.		
1 Remove the screw and remove the wire retainer. Remove the 4 screws on the terminal board and disconnect the connecting wire.	 <p>Terminal board</p> <p>Wire retainer</p> <p>Connecting wire (R17230)</p>	

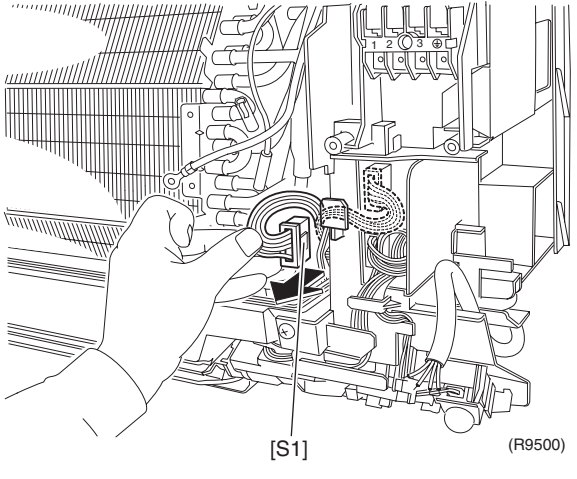
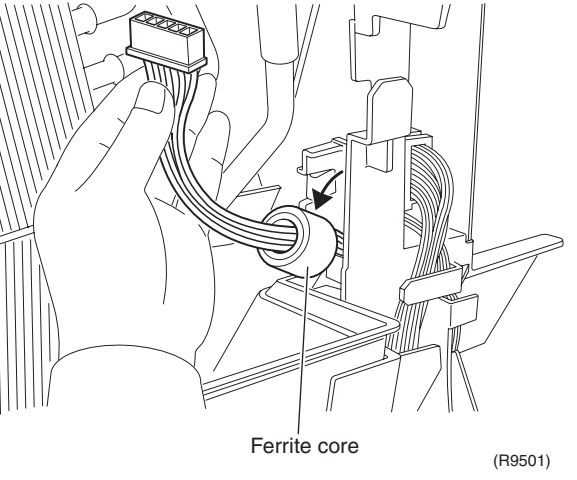
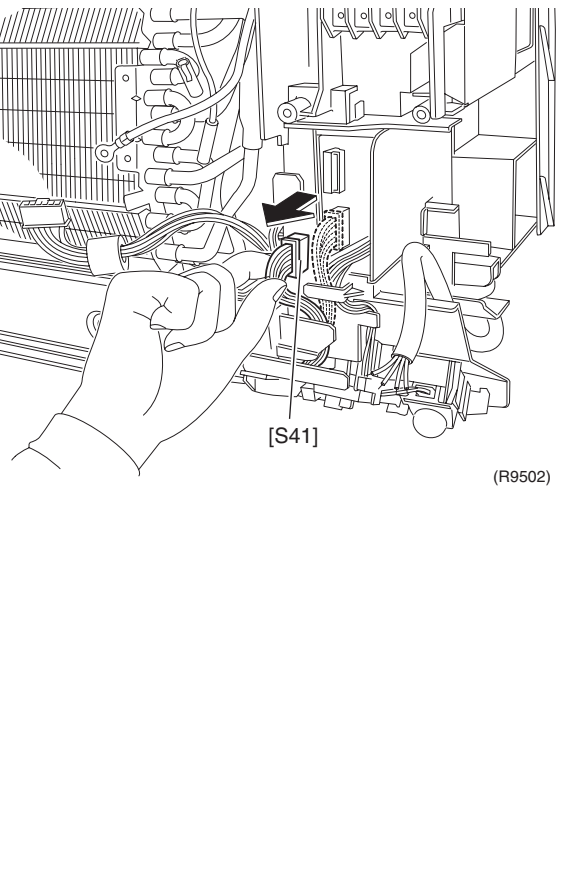
Step	Procedure	Points
2	<p>Disconnect the connector for the fan motor [S1] and release the harness from the hook.</p> 	
3	<p>Release the ferrite core.</p> 	
4	<p>Disconnect the connector for the swing motors [S41].</p> 	

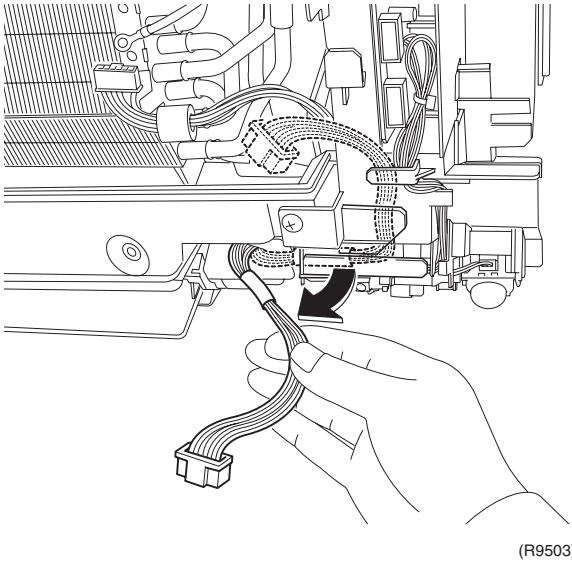
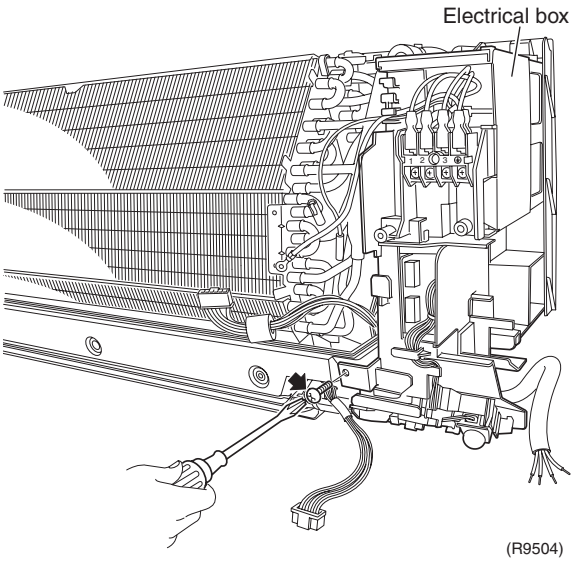
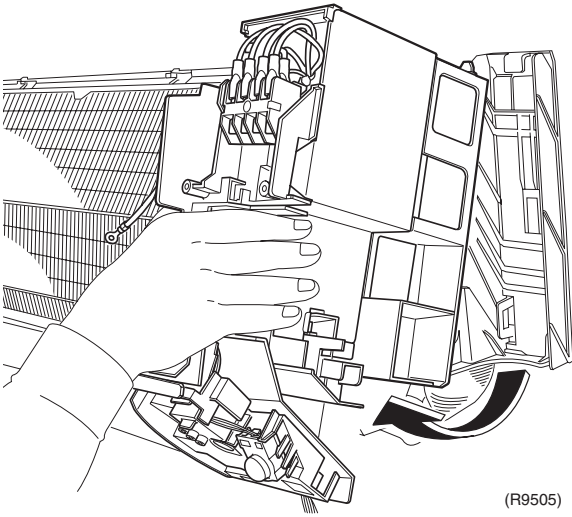
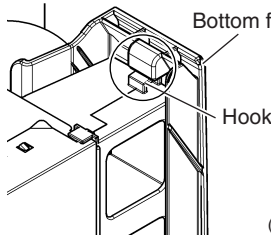
Step	Procedure	Points
5	Release the harness from the hooks.	
	 <p>(R9503)</p>	
6	Remove the screw of the electrical box.	
	 <p>Electrical box</p> <p>(R9504)</p>	
7	Lift up the electrical box from the bottom frame and remove it.	
	 <p>(R9505)</p>	<p>■ Fit the back hook of the electrical box to the bottom frame when reassembling.</p>  <p>Bottom frame</p> <p>Hook</p> <p>(R9647)</p>

# 4. Removal of PCBs

**Procedure**

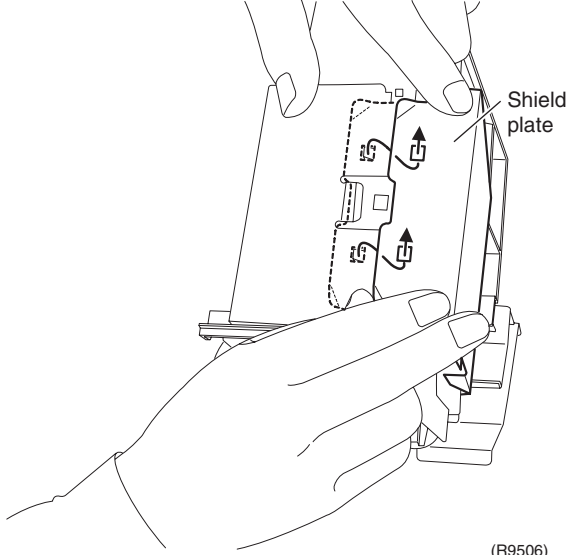
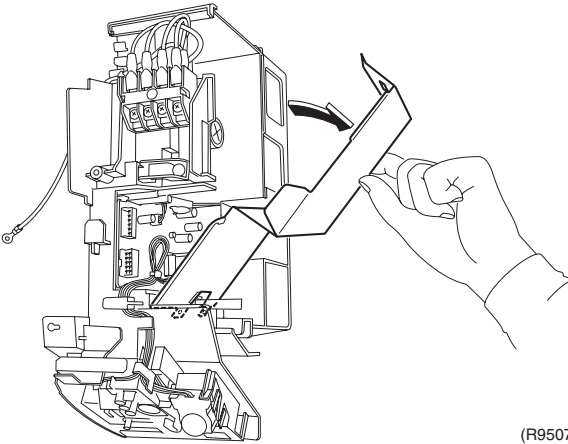
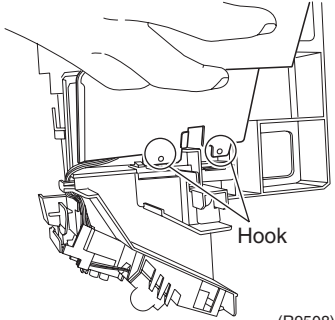
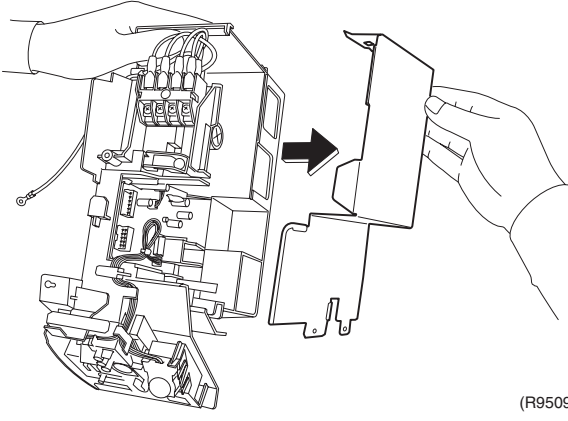

**Warning** Be sure to wait for 10 minutes or more after turning off all power supplies before disassembling work.

Step	Procedure	Points
1.	Remove the signal receiver PCB.	
1	Unfasten the hooks of the shield plate.  <p style="text-align: right;">(R9506)</p>	
2	Open the shield plate.  <p style="text-align: right;">(R9507)</p>	<p>■ The shield plate has 2 hooks at the lower part also.</p>  <p style="text-align: right;">(R9508)</p>
3	Remove the shield plate.  <p style="text-align: right;">(R9509)</p>	

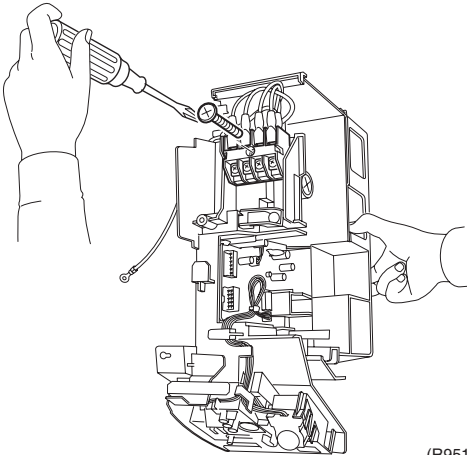
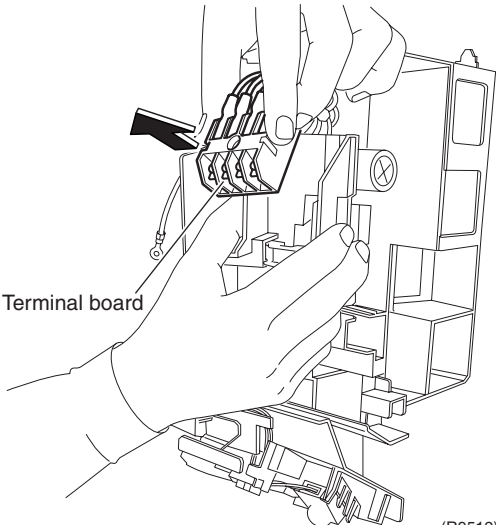
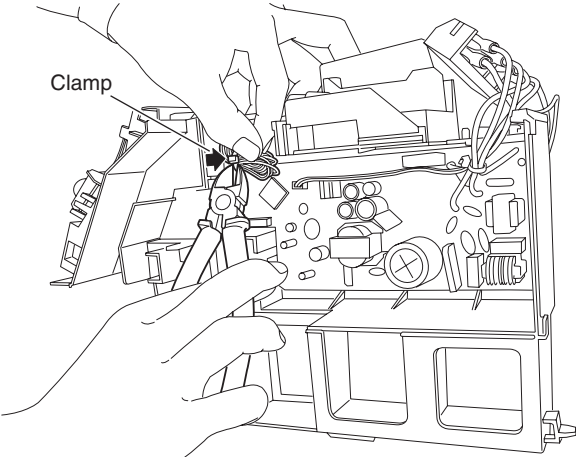
Step	Procedure	Points
4	Remove the screw of the terminal board.  <p style="text-align: right;">(R9511)</p>	
5	Remove the terminal board. (1 hook at the back)  <p>Terminal board</p> <p style="text-align: right;">(R9512)</p>	
6	Cut the clamp.  <p>Clamp</p> <p style="text-align: right;">(R9513)</p>	

Step	Procedure	Points
7	Release the harness from the hook.	<ul style="list-style-type: none"> <li>When reassembling, make sure to hook the harness.</li> </ul>
8	Push and unfasten the hook of the signal receiver unit.	
9	Open the signal receiver unit. Unfasten the hook and remove the signal receiver unit.	
10	Unfasten the hook on the right of the signal receiver PCB. (Then the signal receiver PCB is lifted up.)	

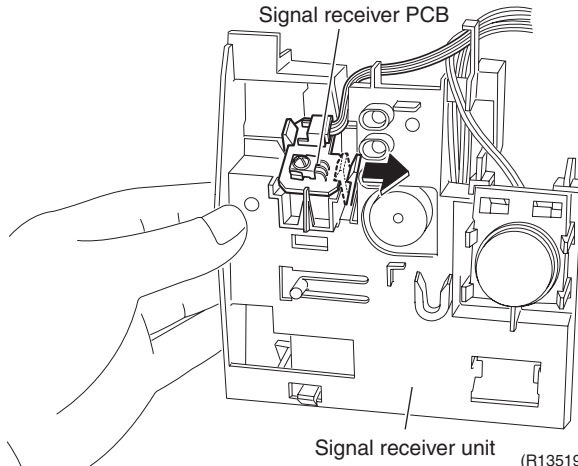
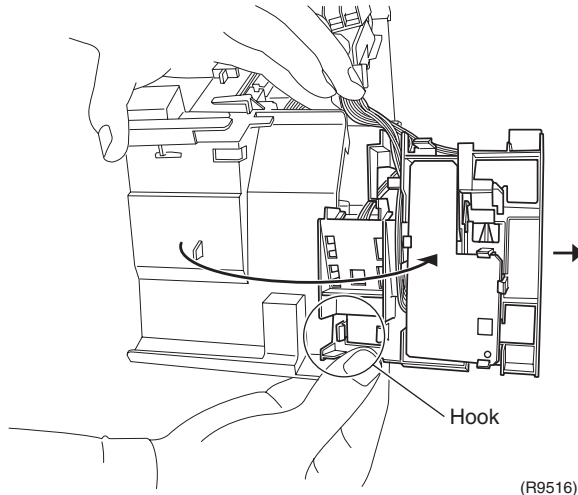
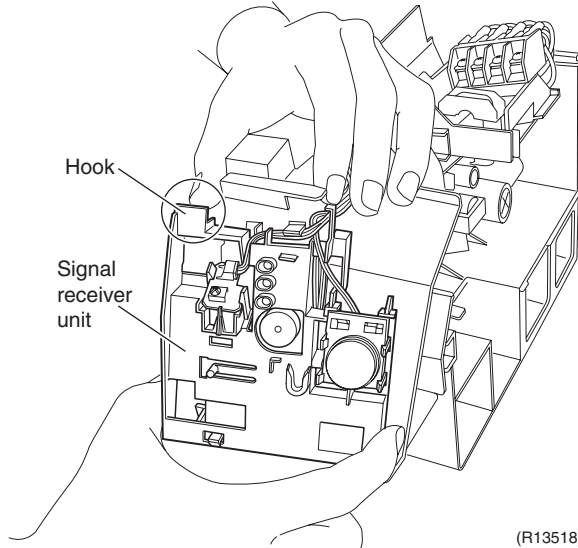
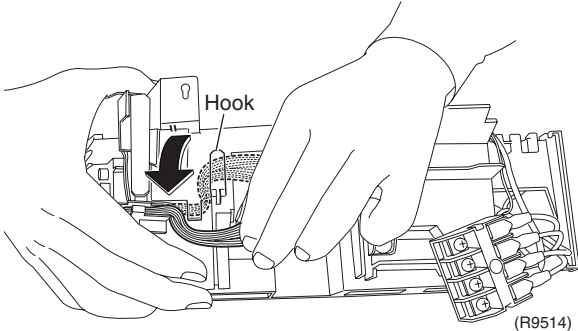

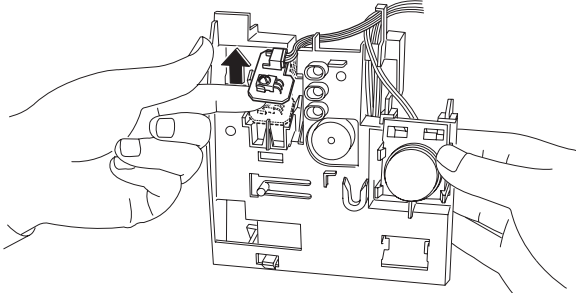
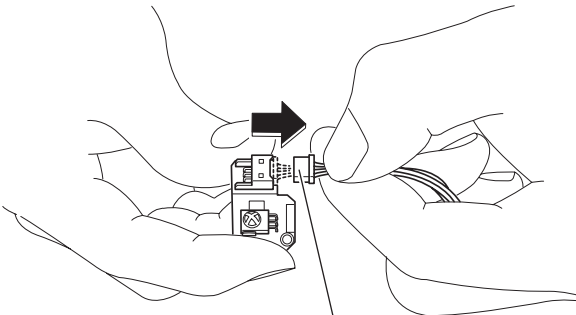
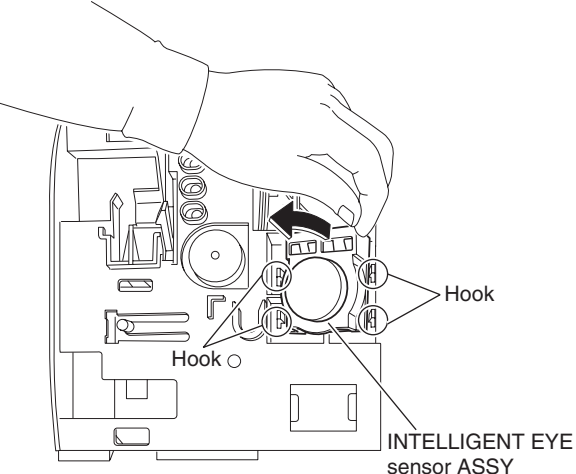
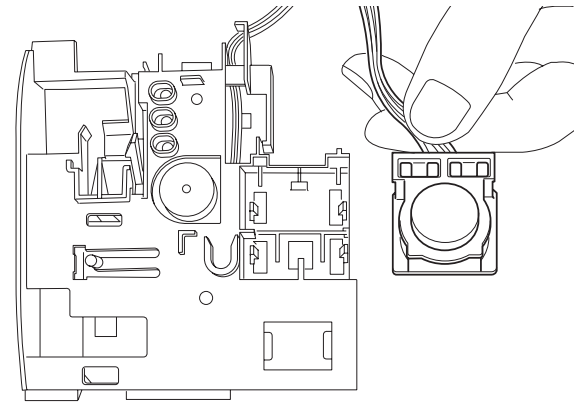

Step	Procedure	Points
<p>11 Remove the signal receiver PCB.</p> <p>12 Disconnect the connector. [S48]: control PCB</p>	 <p>(R9521)</p>  <p>[S48]</p> <p>(R9522)</p>	
<p>2. Remove the INTELLIGENT EYE sensor PCB.</p> <p>1 Unfasten the 2 hooks on the right and then the 2 hooks on the left. Remove the INTELLIGENT EYE sensor ASSY.</p>	 <p>Hook</p> <p>Hook o</p> <p>INTELLIGENT EYE sensor ASSY</p> <p>(R9523)</p>  <p>(R9524)</p>	

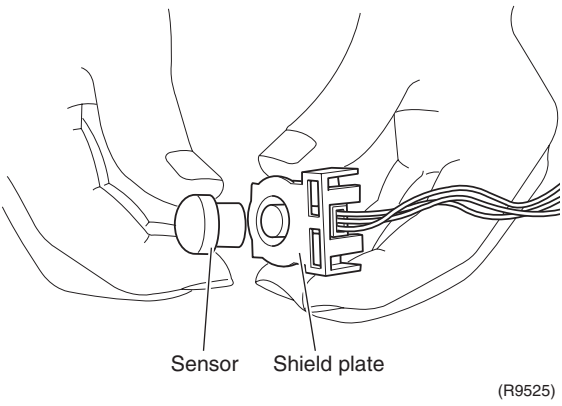
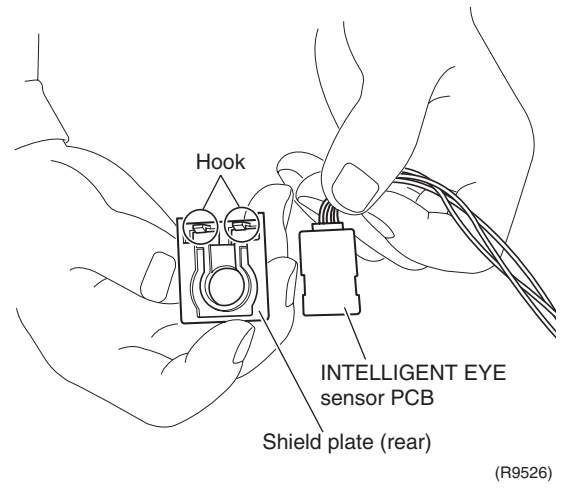
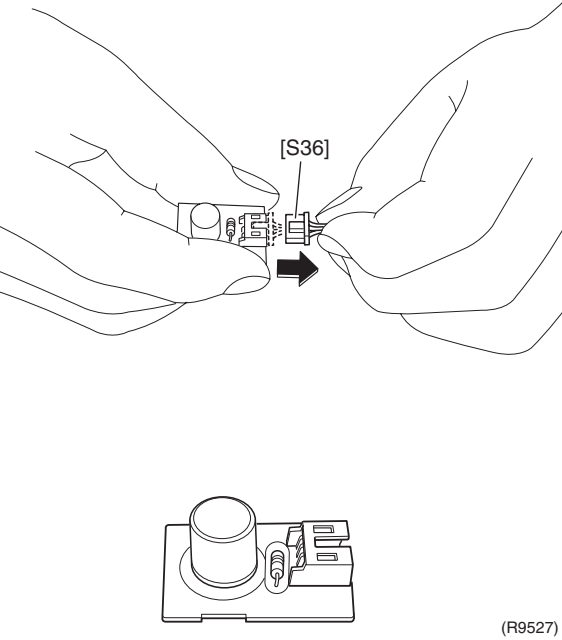
Step	Procedure	Points
2	<p>Remove the sensor from the shield plate.</p> 	<ul style="list-style-type: none"> <li>When reassembling, set the sensor at the position where it “clicks”. Otherwise, the sensor is not completely set.</li> </ul>
3	<p>Remove the shield plate by unfastening the 2 hooks.</p> 	
4	<p>Disconnect the connector. [S36]: control PCB</p> 	

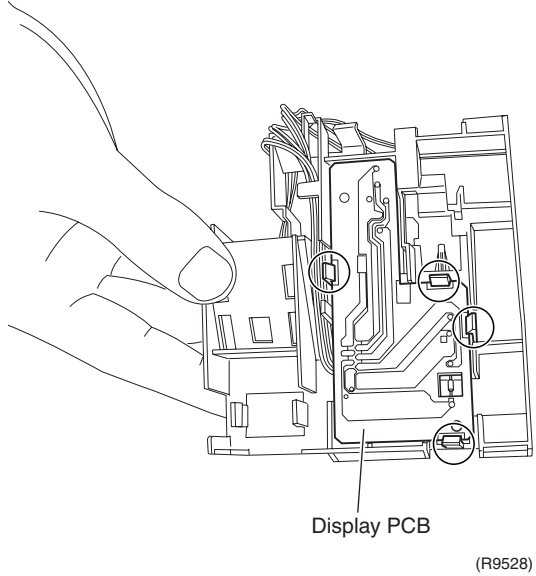
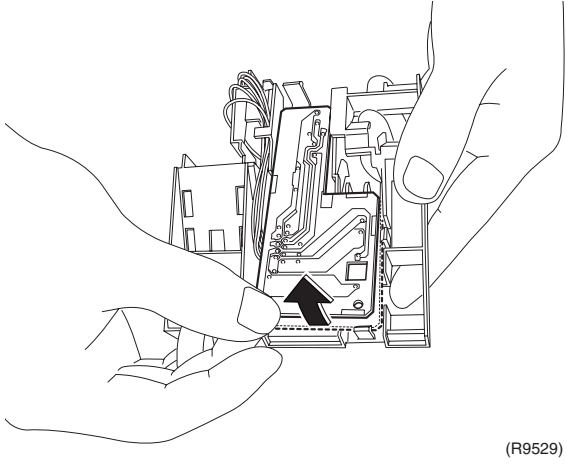
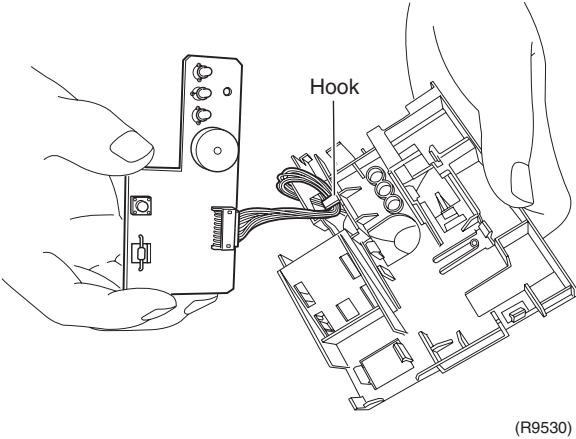
Step	Procedure	Points
3.	Remove the display PCB.	
1	Unfasten the 4 hooks. 	
2	Lift up the display PCB. 	
3	Release the harness from the hook. 	

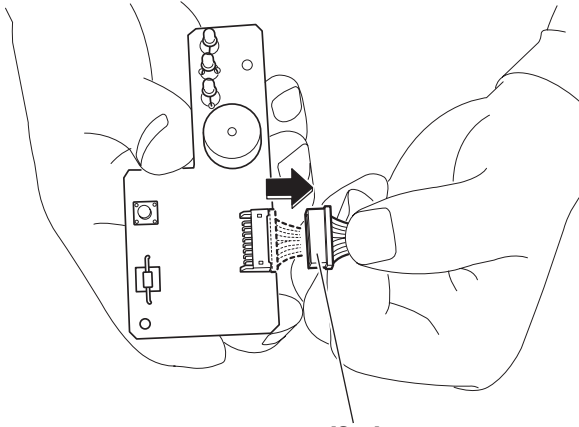
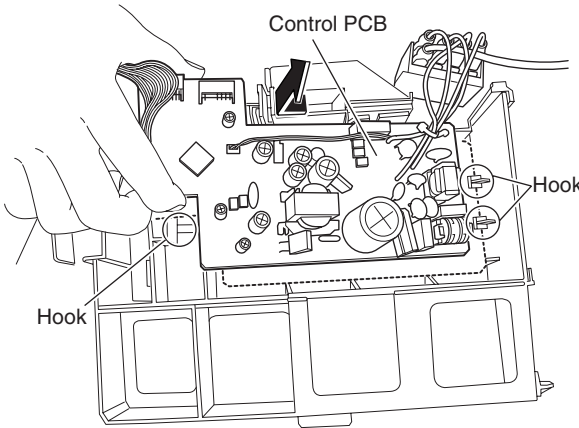
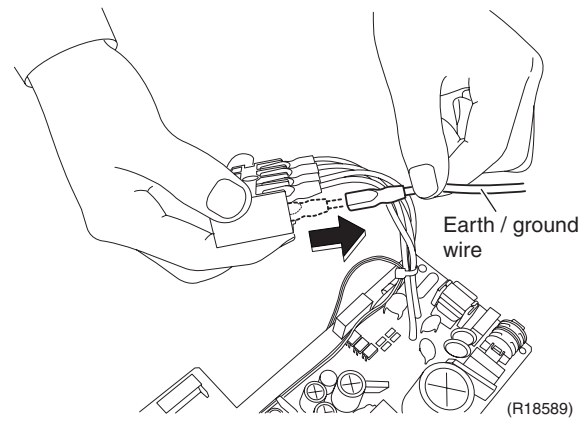
Step	Procedure	Points
4	<p>Disconnect the connector. [S49]: control PCB</p>  <p style="text-align: right;">(R9531)</p>	
4. Remove the control PCB.	<p>1 Unfasten the 3 hooks. Lift up and remove the control PCB.</p>  <p style="text-align: right;">(R9517)</p> <p>2 Pull out the earth / ground wire from the terminal board.</p>  <p style="text-align: right;">(R18589)</p>	

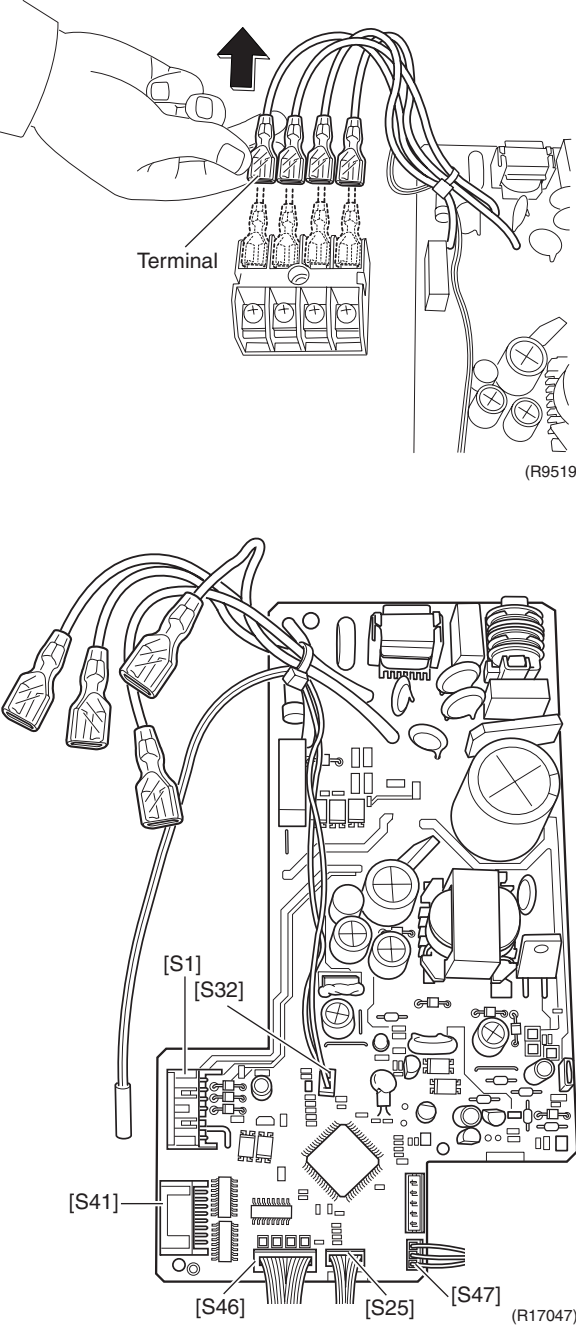
Step	Procedure	Points
<p>3</p>	<p>Pull out the terminals from the terminal board.</p>  <p>(R9519)</p> <p>(R17047)</p>	<p>[S1] : DC fan motor                  [S25] : INTELLIGENT EYE sensor PCB                  [S32] : indoor heat exchanger thermistor                  [S41] : swing motors                  [S46] : display PCB                  [S47] : signal receiver PCB</p>

# 5. Removal of Horizontal Blades / Swing Motors

**Procedure**

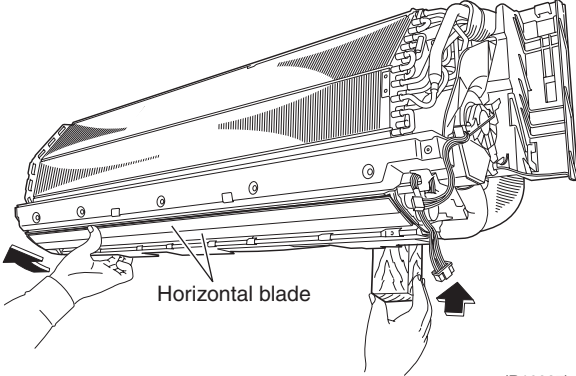
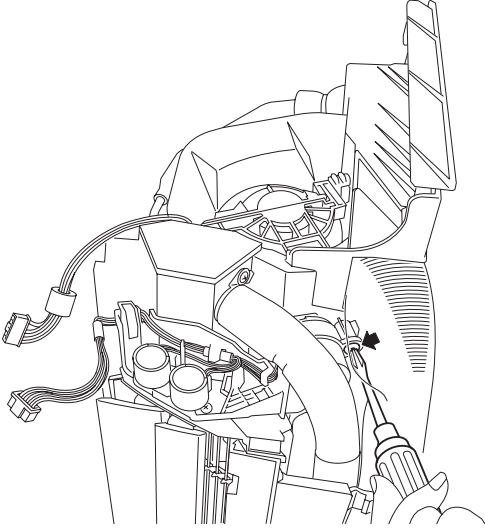
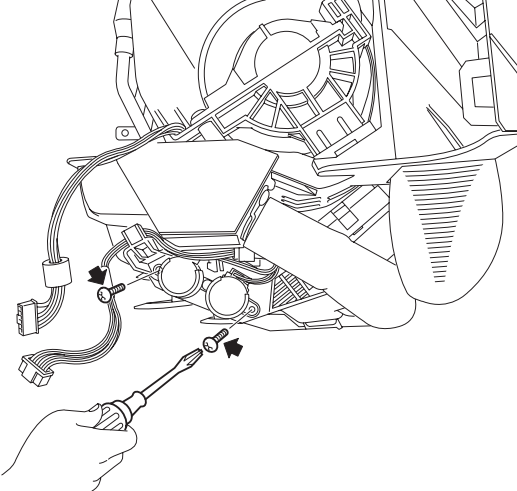

**Warning** Be sure to wait for 10 minutes or more after turning off all power supplies before disassembling work.

Step	Procedure	Points
1. Remove the horizontal blades.	 <p style="text-align: center;">Horizontal blade</p> <p style="text-align: right;">(R16287)</p>	
2. Remove the screw at the rear of the indoor unit.	 <p style="text-align: right;">(R9533)</p>	
3. Remove the 2 screws (front and rear).	 <p style="text-align: right;">(R9534)</p>	

Step		Procedure	Points
4	Release the shafts in turn.	<p>Horizontal blade</p> <p>right</p> <p>(R9535)</p> <p>left</p> <p>(R9536)</p> <p>inner right</p> <p>(R9537)</p> <p>inner left</p> <p>(R9538)</p>	<ul style="list-style-type: none"> <li>■ Removing order (right → left → inner right → inner left)</li> </ul>

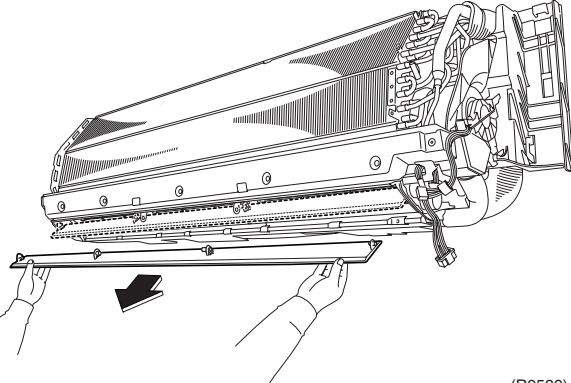
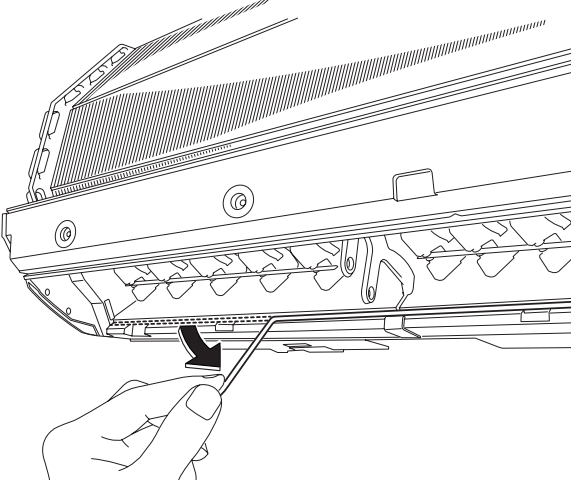
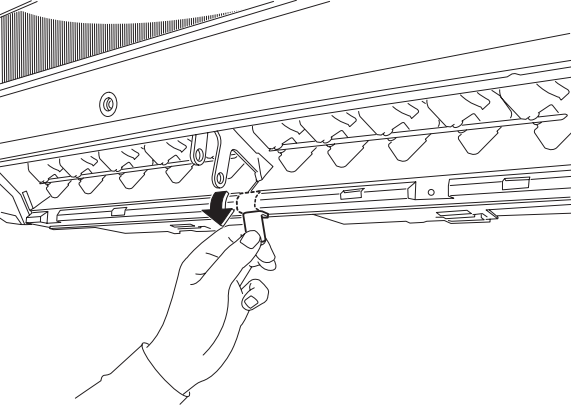
Step		Procedure	Points
5	Remove the horizontal blades.	 <p>(R9539)</p>	
2.	Remove the air outlet ASSYs.		
1	Remove the sealing material (horizontal).	 <p>(R9540)</p>	
2	Remove the sealing material (vertical, 2 positions).	 <p>(R9541)</p>	

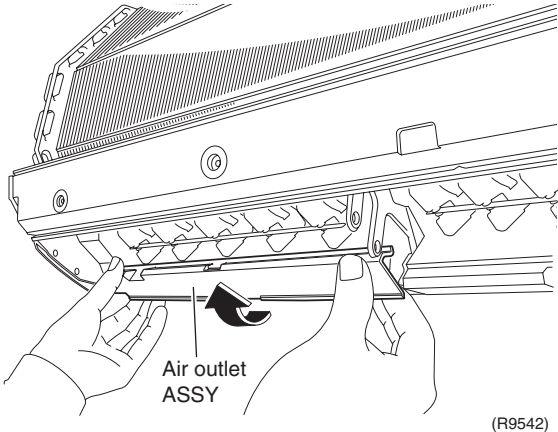
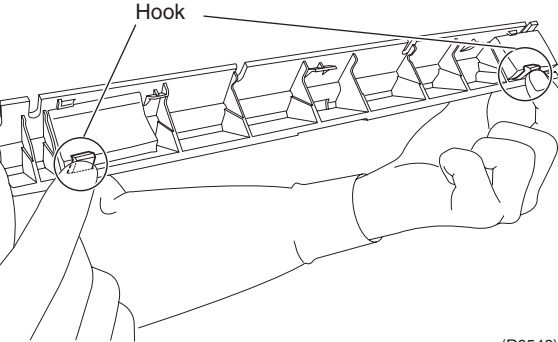
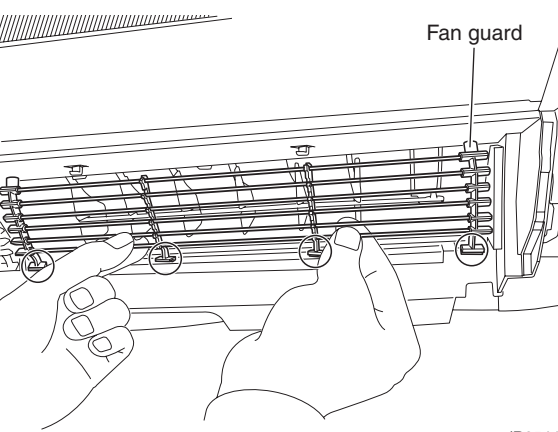
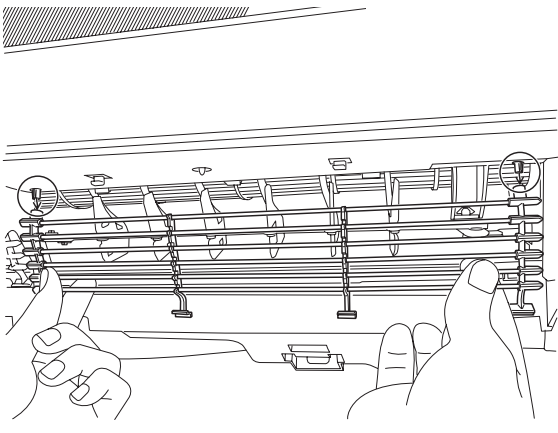

Step	Procedure	Points
3	Remove the left air outlet ASSY by pushing the 2 hooks at the back.	<ul style="list-style-type: none"> <li>■ Remove the center and right air outlet ASSYs likewise.</li> </ul>
	 <p style="text-align: center;">Air outlet ASSY</p> <p style="text-align: right;">(R9542)</p>	
	 <p style="text-align: center;">Hook</p> <p style="text-align: right;">(R9543)</p>	
4	Unfasten the 4 lower hooks and the 2 upper hooks and remove the fan guard. (The U.S. models only)	<ul style="list-style-type: none"> <li>■ Remove the other 2 fan guards likewise.</li> </ul>
	 <p style="text-align: center;">Fan guard</p> <p style="text-align: right;">(R9544)</p>	
	 <p style="text-align: right;">(R9545)</p>	

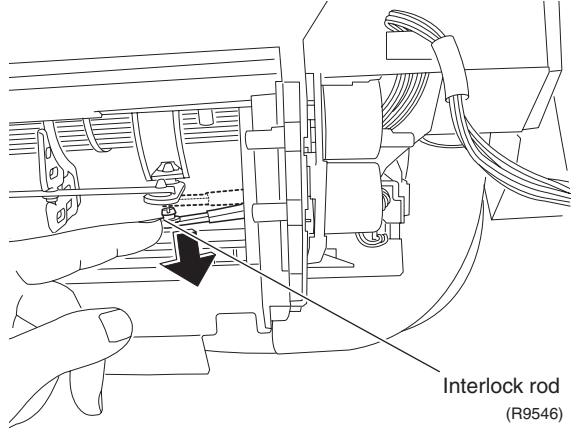
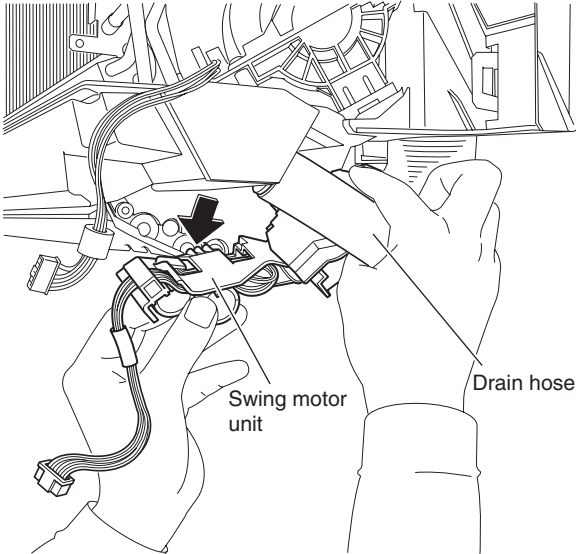
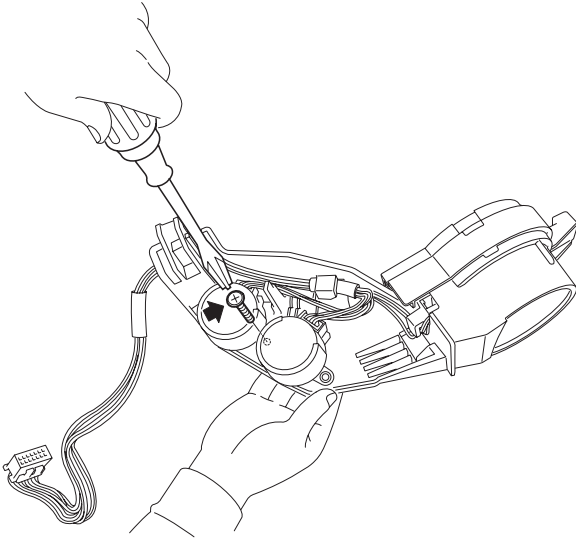
Step	Procedure	Points
3.	Remove the swing motors for horizontal blades.	
1	<p>Release the interlock rod.</p> 	
2	<p>Pull out the drain hose, then remove the swing motor unit.</p> 	
3	<p>Remove the screw at the center.</p> 	

Step	Procedure	Points
4	Remove the 2 pivots.	
5	Remove the swing motors.	<p> <b>Caution</b>  <b>When reassembling, do not confuse the installing order of the 2 motors and the colors of the connectors.</b>  <b>If you set the connectors or motors opposite, the horizontal blades do not move smoothly or the noise may be heard.</b></p>
6	Disconnect the connector to remove the swing motor.	<p>(1) Set the swing motor for the upper blade first.          (connector: white)          (2) Then, set the swing motor for the lower blade.          (connector: red)          (3) Fix both the swing motors with a screw.</p>

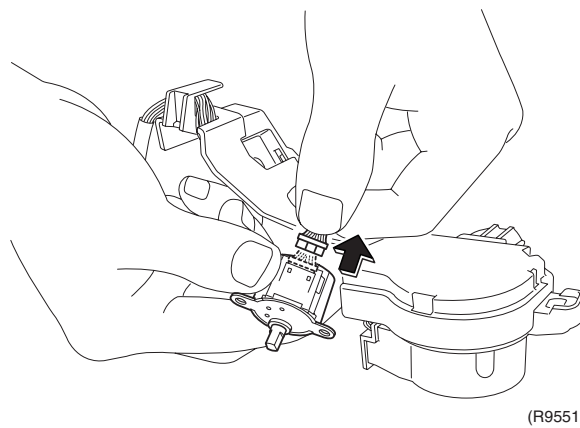
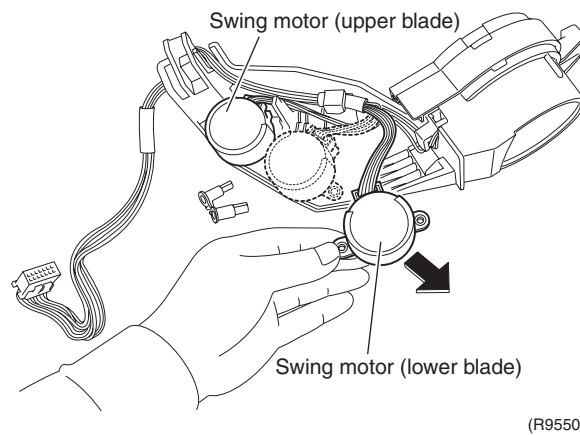
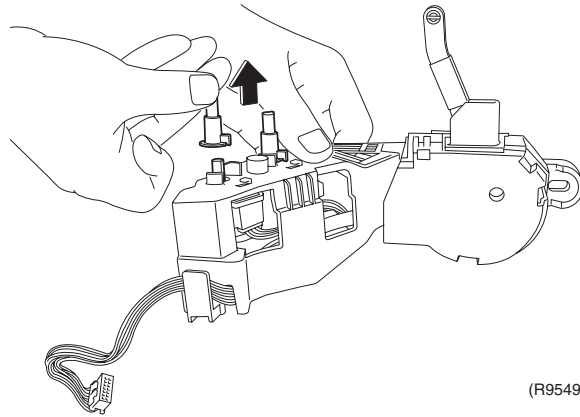

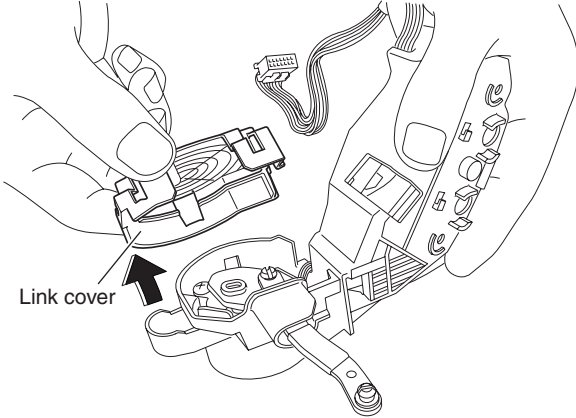
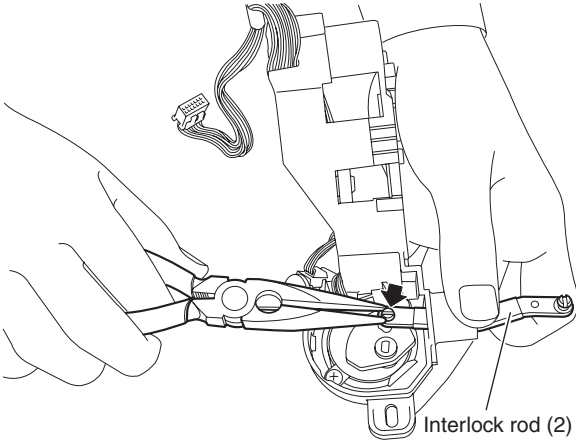
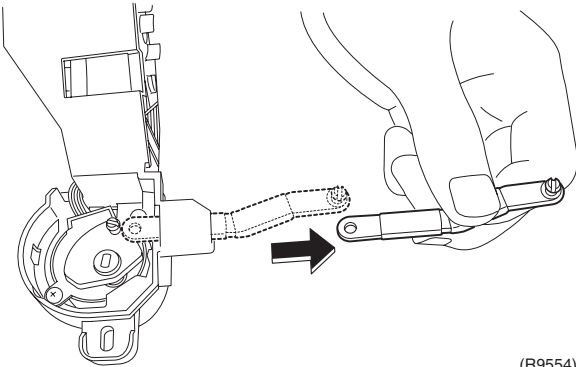
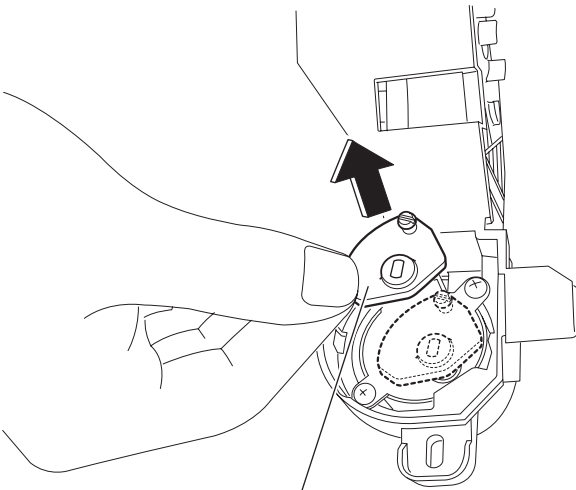
Step	Procedure	Points
4.	Remove the swing motor for vertical blades.	
1	Remove the link cover.	
	 <p style="text-align: right;">(R9552)</p>	
2	Remove the interlock rod (2) with pliers.	
	 <p style="text-align: right;">(R9553)</p>	
	 <p style="text-align: right;">(R9554)</p>	
3	Remove the interlock rod (1).	
	 <p style="text-align: right;">(R9555)</p>	

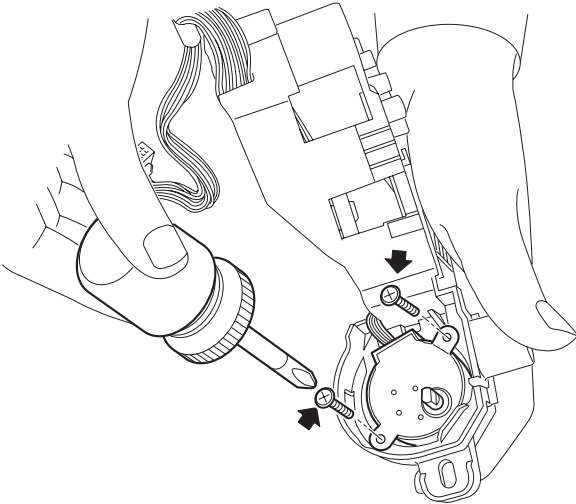
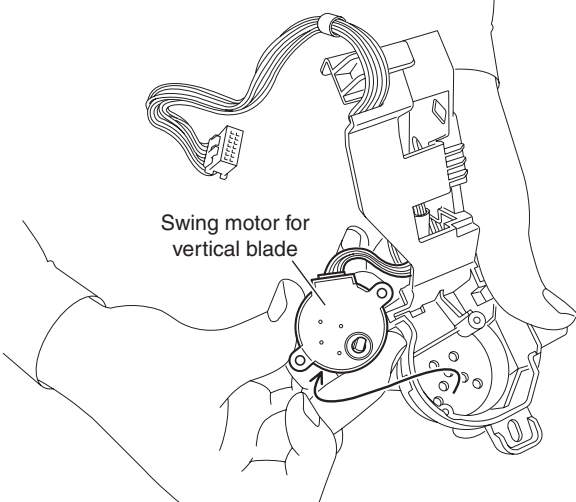
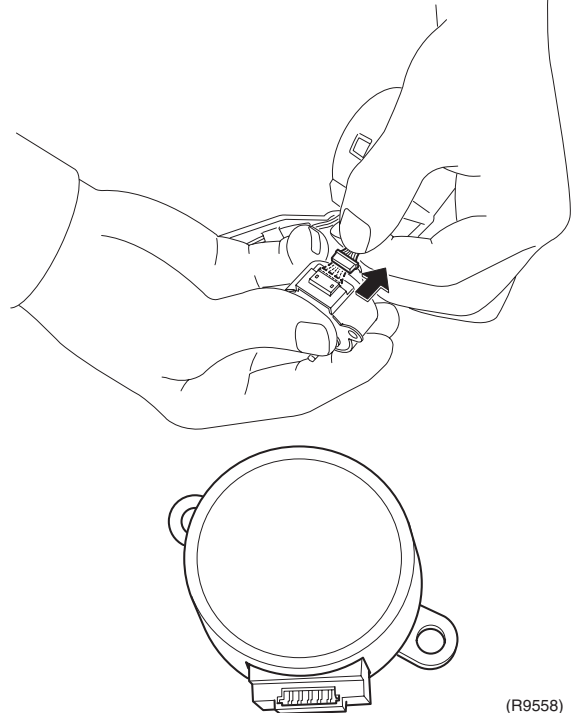
Step	Procedure	Points
4	Remove the 2 screws.	
	 <p style="text-align: right;">(R9556)</p>	
5	Remove the swing motor for the vertical blade.	
	 <p style="text-align: right;">(R9557)</p>	
6	Disconnect the connector.	
	 <p style="text-align: right;">(R9558)</p>	

# 6. Removal of Fan Motor

**Procedure**



**Warning** Be sure to wait for 10 minutes or more after turning off all power supplies before disassembling work.

Step	Procedure	Points
1	Loosen the screw of the fan motor from the air outlet.	
	<p style="text-align: right;">(R9559)</p>	
2	Remove the screw of the fan motor fixing plate (upper).	
	<p style="text-align: center;">Fan motor fixing plate (upper)</p> <p style="text-align: right;">(R17238)</p>	

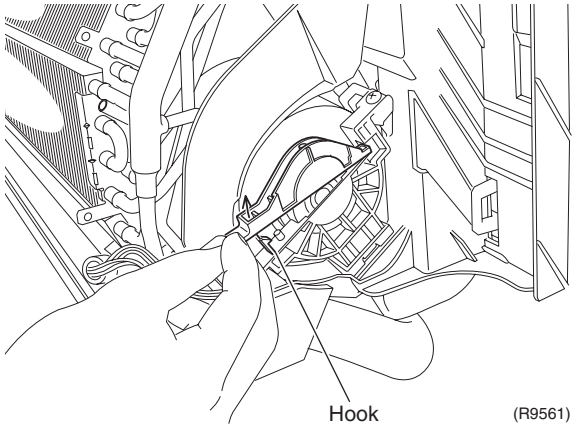
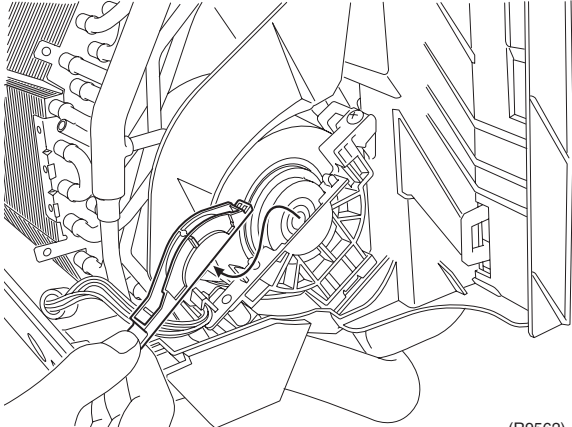
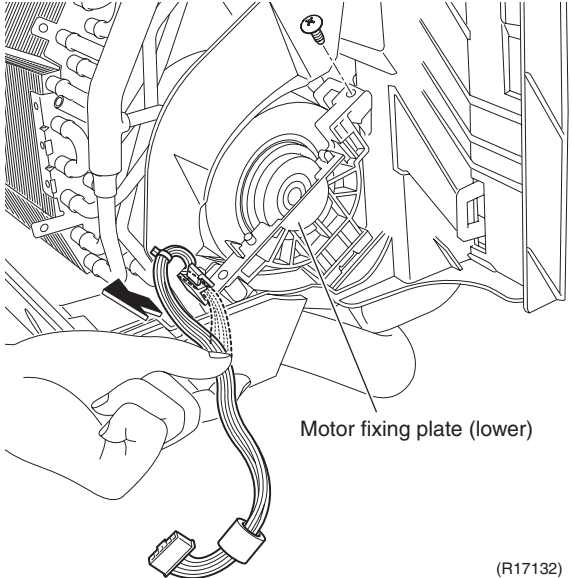
Step	Procedure	Points
3	Unfasten the hook at the front and remove the motor fixing plate (upper).	
	 <p style="text-align: center;">Hook (R9561)</p>	
	 <p style="text-align: center;">(R9562)</p>	
4	Release the harness from the hook, and remove the screw of the motor fixing plate (lower).	
	 <p style="text-align: center;">Motor fixing plate (lower) (R17132)</p>	

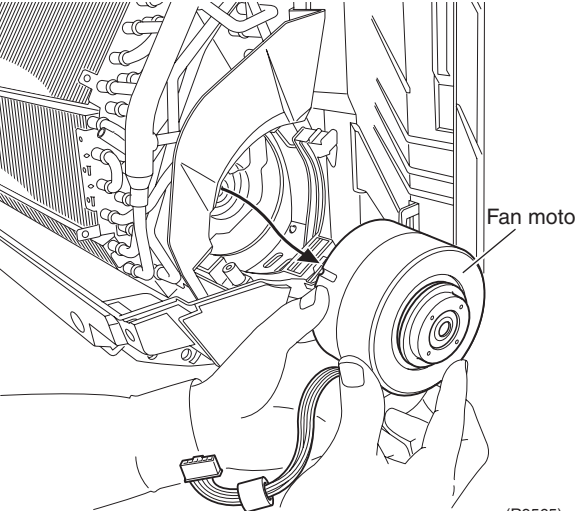
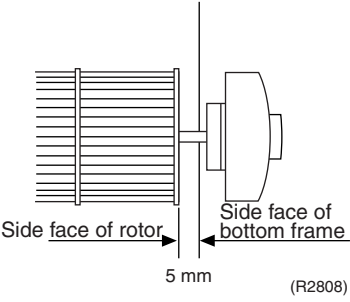
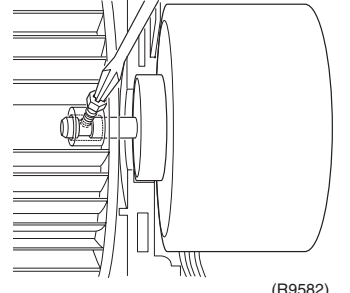
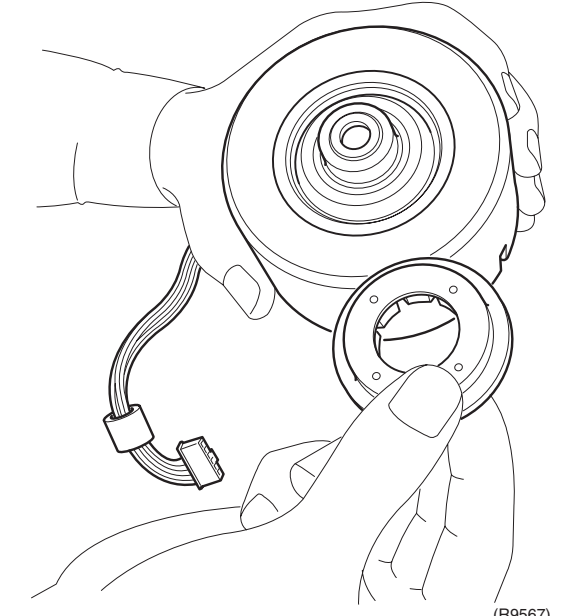
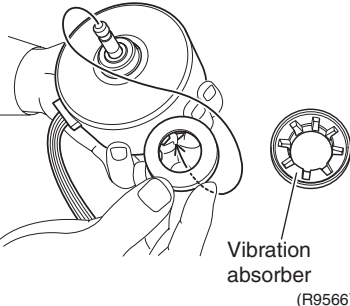
Step	Procedure	Points
5	Remove the motor fixing plate (lower).	<ul style="list-style-type: none"> <li>When reassembling the fan motor and the fan rotor, provide as much as 5 mm of play between the side face of the rotor and the bottom frame.</li> </ul>
6	Remove the fan motor.	    <ol style="list-style-type: none"> <li>Insert the fan motor with approx. 5 mm left.</li> <li>Tighten the screw until it stops. Then give the screw one more turn.</li> <li>Rotate the fan rotor and confirm the fan motor and the fan rotor are installed appropriately.</li> <li>Tighten the screw completely if appropriate.</li> <li>If not appropriate, go back to (1).</li> </ol>
7	Remove the vibration absorber.	<ul style="list-style-type: none"> <li>When reassembling, engage the vibration absorber completely.</li> </ul>  



# 7. Removal of Indoor Heat Exchanger

**Procedure**



**Warning** Be sure to wait for 10 minutes or more after turning off all power supplies before disassembling work.

Step	Procedure	Points
1. Disconnect the refrigerant piping.		<p><b>Preparation</b></p> <ul style="list-style-type: none"> <li>Remove the electrical box according to the “Removal of Electrical Box”.</li> </ul>
1 Hold the indoor unit up with a piece of wood etc.	<p>(R16521)</p>	<p><b>Caution</b></p> <p>If the refrigerant leaks, repair the leakage, then collect all refrigerant from the unit. After conducting vacuum drying, recharge a proper amount of refrigerant.</p>
2 Pull out the drain hose.	<p>Drain hose</p> <p>(R16522)</p>	<p><b>Caution</b></p> <p>From the viewpoint of global environment protection, be sure to use a vacuum pump for air purging.</p> <p><b>Caution</b></p> <p>In pump-down work, be sure to stop the compressor before disconnecting the refrigerant piping. If the refrigerant piping is disconnected with the compressor operating and the stop valve open, air may be sucked in to generate an over-pressure in refrigeration cycle, thus resulting in pipe rupture or accidental injury.</p>
3 Unscrew the flare nuts for gas piping and liquid piping.	<p>Gas piping</p> <p>Liquid piping</p> <p>(R16523)</p>	<ul style="list-style-type: none"> <li>Place a plastic sheet under the drain pan to prevent from wetting the floor with remaining drain.</li> <li>If the drain hose is embedded in the wall, disconnect the drain hose beforehand.</li> <li>Carry out the removal work with 2 wrenches.</li> <li>When the pipings are disconnected, protect both the openings of pipe and unit from entering moisture.</li> </ul>

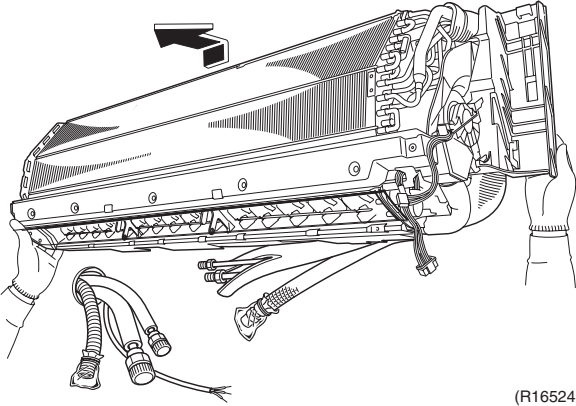
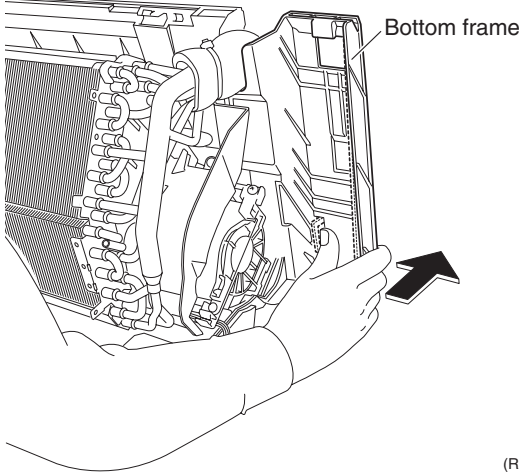
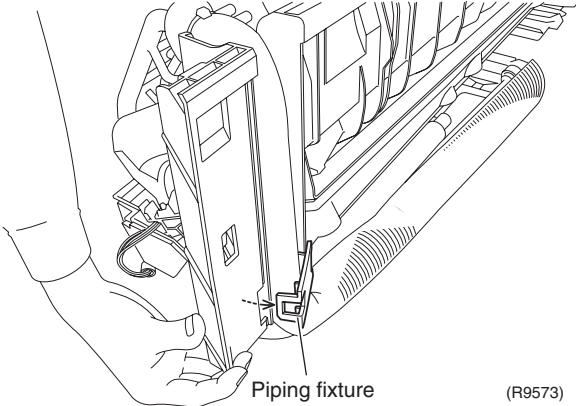
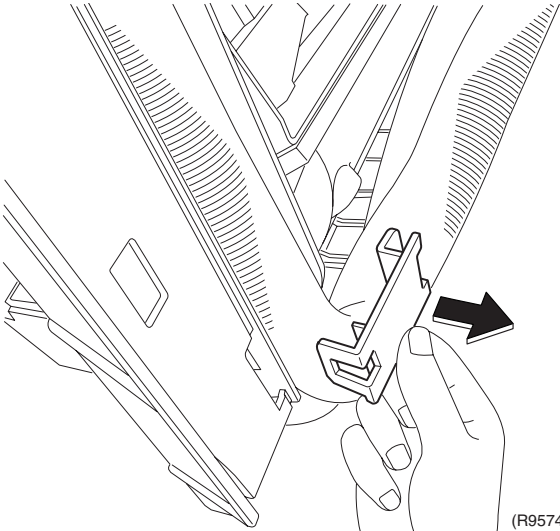
Step	Procedure	Points
2. Remove the piping fixture.	<p data-bbox="153 248 172 275">1</p> <p data-bbox="201 248 453 344">Detach the indoor unit from the installation plate.</p>  <p data-bbox="1007 618 1070 640">(R16524)</p> <p data-bbox="153 651 172 678">2</p> <p data-bbox="201 651 464 678">Push the bottom frame.</p>  <p data-bbox="884 685 1023 707">Bottom frame</p> <p data-bbox="1007 1126 1070 1149">(R9572)</p> <p data-bbox="153 1160 172 1187">3</p> <p data-bbox="201 1160 411 1220">Release the piping fixture.</p>  <p data-bbox="743 1554 866 1576">Piping fixture</p> <p data-bbox="999 1559 1062 1581">(R9573)</p> <p data-bbox="153 1592 172 1619">4</p> <p data-bbox="201 1592 416 1653">Remove the piping fixture.</p>  <p data-bbox="999 2114 1062 2136">(R9574)</p>	

Step	Procedure	Points
3.	Remove the indoor heat exchanger.	
1	Slightly widen the auxiliary piping.	
2	Remove the 2 screws on the left side.	<p> <b>Caution</b>                      When removing or reassembling the indoor heat exchanger, be sure to wear gloves or wrap the indoor heat exchanger with cloths. (You may be injured by the fins.)</p>
3	Push the hook on the right side and unfasten it.	
4	Lift up and remove the indoor heat exchanger.	<p>■ Press the right side of the indoor heat exchanger, and lift it up from the left side.</p>

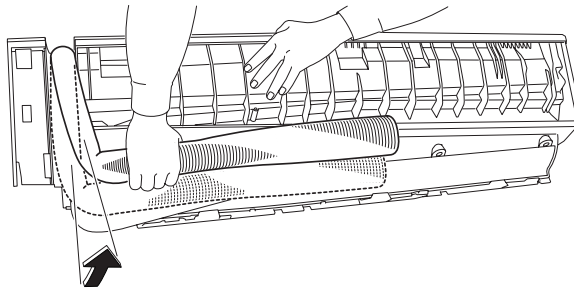

(R9575)

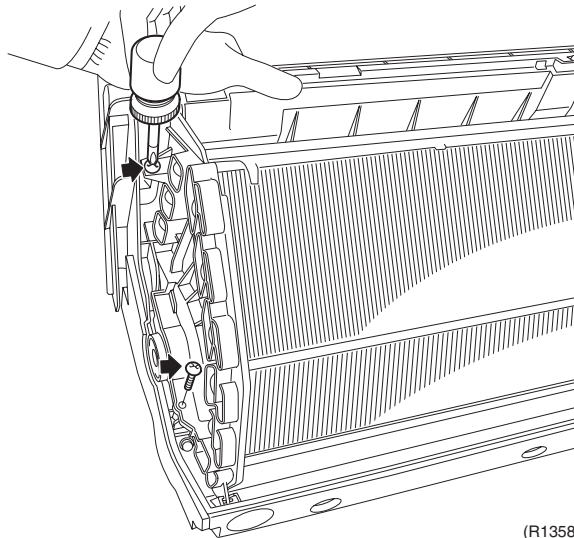

(R13580)

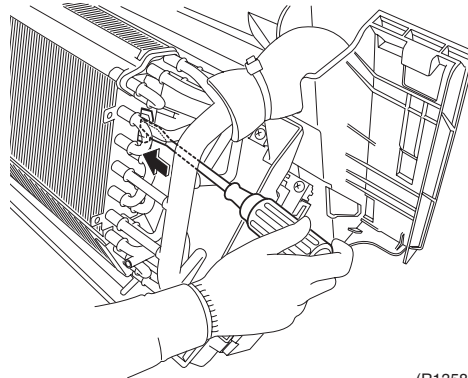

(R13581)

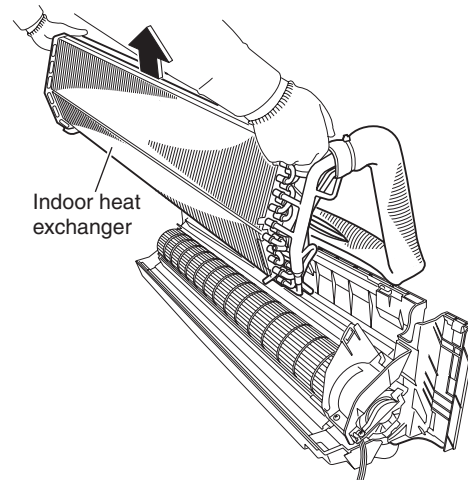

(R9578)

# 8. Removal of Fan Rotor

**Procedure**

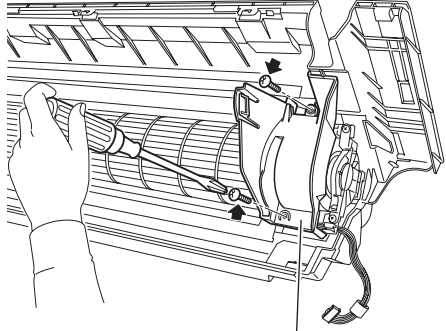
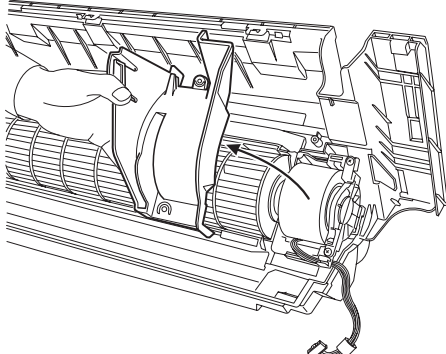
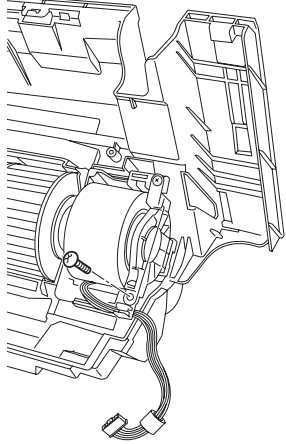
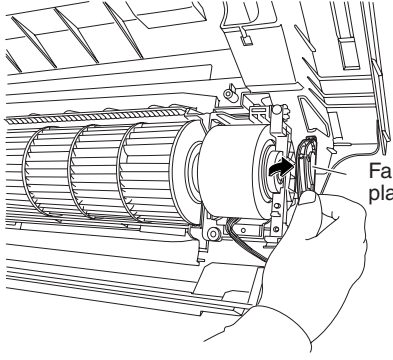

**Warning** Be sure to wait for 10 minutes or more after turning off all power supplies before disassembling work.

Step	Procedure	Points
<p>1. Remove the right side plate.</p> <p>1 Remove the 2 screws.</p> <p>2 Lift the right side plate and remove it.</p>	 <p style="text-align: center;">Right side plate (R9579)</p>  <p style="text-align: right;">(R9580)</p>	
<p>2. Remove the fan rotor.</p> <p>1 Remove the screw of the fan motor fixing plate.</p> <p>2 Remove the screw of the fan motor fixing plate and remove it.</p>	 <p style="text-align: right;">(R17121)</p>  <p style="text-align: right;">Fan motor fixing plate (R9581)</p>	

Step	Procedure	Points
3	Loosen the screw of the fan rotor.	
4	Remove the fan motor.	<p>■ When reassembling the fan motor and the fan rotor, provide as much as 5 mm of play between the side face of the rotor and the bottom frame.</p>
5	Remove the fan rotor.	<ol style="list-style-type: none"> <li>(1) Insert the fan motor with approx. 5 mm left.</li> <li>(2) Tighten the screw until it stops. Then give the screw one more turn.</li> <li>(3) Rotate the fan rotor and confirm the fan motor and the fan rotor are installed appropriately.</li> <li>(4) Tighten the screw completely if appropriate.</li> <li>(5) If not appropriate, go back to (1).</li> </ol>

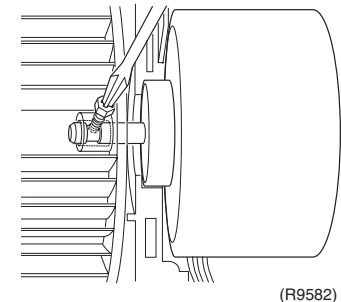
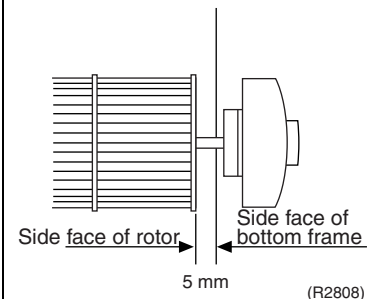
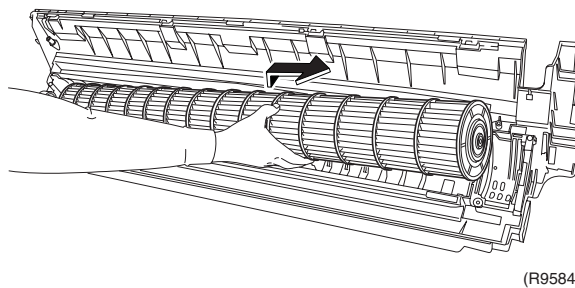
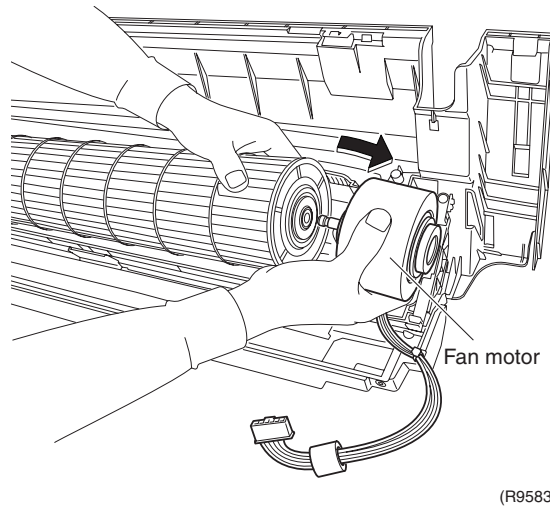
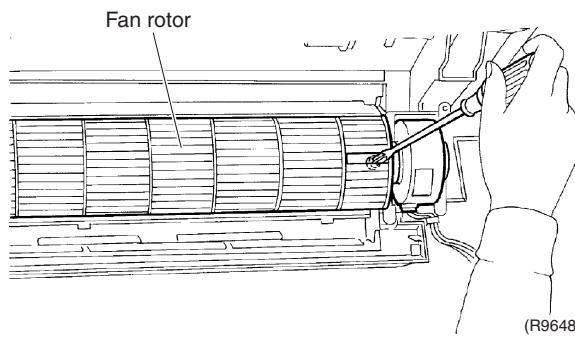

# 9. Removal of Vertical Blade ASSY

**Procedure**



**Warning**

Be sure to wait for 10 minutes or more after turning off all power supplies before disassembling work.

Step	Procedure	Points
<p>Unfasten the 2 hooks of each vertical blade ASSY. Remove the 3 vertical blade ASSYs.</p>		<ul style="list-style-type: none"> <li>■ When reassembling, connect the 3 vertical blade ASSYs. Fasten the hooks at the connecting points.</li> </ul>
		<p>(R16979)</p> <ul style="list-style-type: none"> <li>■ Each vertical blade ASSY is united with a drain pan ASSY.</li> </ul>

# Revision History

Month / Year	Version	Revised contents
02 / 2013	Si04-958	First edition

Warning



- Daikin products are manufactured for export to numerous countries throughout the world. Prior to purchase, please confirm with your local authorised importer, distributor and/or retailer whether this product conforms to the applicable standards, and is suitable for use, in the region where the product will be used. This statement does not purport to exclude, restrict or modify the application of any local legislation.
- Ask a qualified installer or contractor to install this product. Do not try to install the product yourself. Improper installation can result in water or refrigerant leakage, electrical shock, fire or explosion.
- Use only those parts and accessories supplied or specified by Daikin. Ask a qualified installer or contractor to install those parts and accessories. Use of unauthorised parts and accessories or improper installation of parts and accessories can result in water or refrigerant leakage, electrical shock, fire or explosion.
- Read the User's Manual carefully before using this product. The User's Manual provides important safety instructions and warnings. Be sure to follow these instructions and warnings.

If you have any enquiries, please contact your local importer, distributor and/or retailer.

### Cautions on product corrosion

1. Air conditioners should not be installed in areas where corrosive gases, such as acid gas or alkaline gas, are produced.
2. If the outdoor unit is to be installed close to the sea shore, direct exposure to the sea breeze should be avoided. If you need to install the outdoor unit close to the sea shore, contact your local distributor.

### Dealer

### **DAIKIN INDUSTRIES, LTD.**

Head Office:  
Umeda Center Bldg., 2-4-12, Nakazaki-Nishi,  
Kita-ku, Osaka, 530-8323 Japan

Tokyo Office:  
JR Shinagawa East Bldg., 2-18-1, Konan,  
Minato-ku, Tokyo, 108-0075 Japan

[http://www.daikin.com/global\\_ac/](http://www.daikin.com/global_ac/)

©All rights reserved