





Si04-951

REMOVAL PROCEDURE



S E R V I C E M A N U A L

2.5/3.5 kW Class 9000/12000 Btu/h Class

-  Indoor Unit
-  Inverter / Non-Inverter
-  Wall Mounted Type



Service Manual Removal Procedure

Indoor Unit

●Cooling Only

**FTKS09GV2S
FTKS12GV2S**

**FTN25HV1A
FTN35HV1A**

●Heat Pump

**CTXS25HVLD
CTXS35HVLD**

**FTXS25HV2C
FTXS25HV2CW
FTXS25HV2CN
FTXS25HV2CP**

**FTXS35HV2C
FTXS35HV2CW
FTXS35HV2CN
FTXS35HV2CP**

FTYN35HV1A

Table of Contents

1. Removal of Air Filters	2
2. Removal of Front Panel	4
3. Removal of Front Grille	5
4. Removal of Horizontal Blades / Vertical Blades	7
5. Removal of Electrical Box	10
6. Removal of PCBs	13
7. Removal of Drain Pan Unit / Swing Motor	19
8. Removal of Fan Motor	23
9. Removal of Indoor Heat Exchanger	25
10. Removal of Fan Rotor	28



Note: ♦ The illustrations may be slightly different depending on the model.

1. Removal of Air Filters

Procedure



Warning

Be sure to wait for 10 minutes or more after turning off all power supplies before disassembling work.

Step	Procedure	Points
<p>1. Appearance feature</p>		<p>Warning Dangerous: High voltage A high voltage is applied to all the electric circuits of this product including thermistors.</p> <ul style="list-style-type: none"> ■ When the signal receiver catches a signal from the remote controller, the receiving tone sounds and the operation lamp blinks immediately to confirm the signal reception. ■ When the [ON/OFF] button is kept pressed for 5 seconds, the forced cooling operation is performed for about 15 minutes.
<p>2. Remove the air filter.</p> <p>1 Open the front panel to the position where it stops.</p> <p>2 Slightly push up the center knob of the air filter and unfasten the hooks.</p> <p>3 Pull out the air filter downward and remove it.</p>		<ul style="list-style-type: none"> ■ The air filter is not marked for difference between the right and left sides. ■ Insert the air filter with the "FRONT" mark faced up. ■ The air filter can be set easily by inserting it along the guides. ■ Be sure to insert the hooks (at 2 lower positions) when reassembling the air filter.

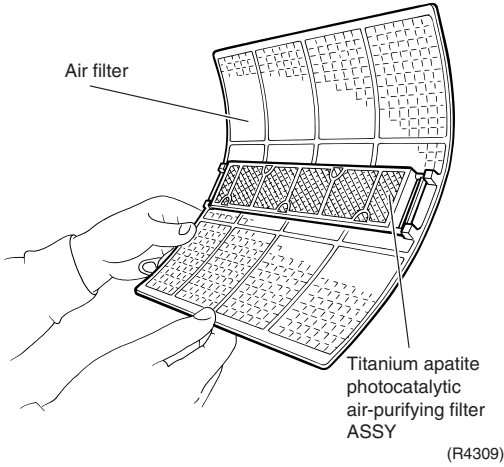
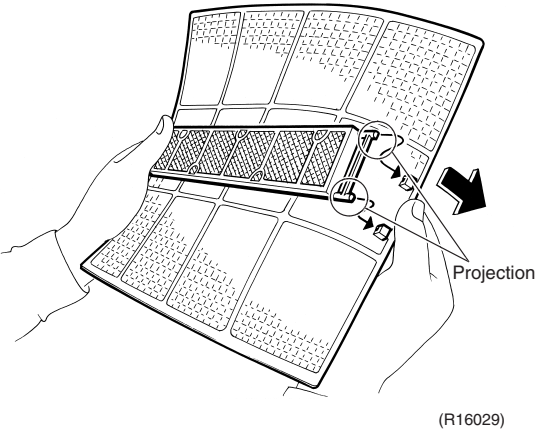
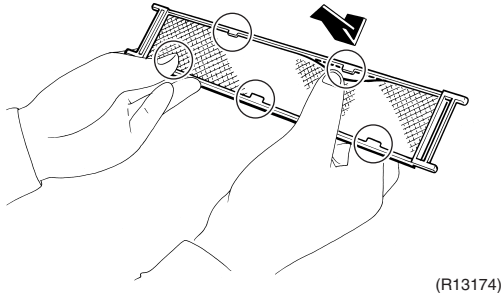
Step	Procedure	Points
3.	Remove the Titanium apatite photocatalytic air-purifying filters.	<ul style="list-style-type: none"> ■ Some models have no Titanium apatite photocatalytic air-purifying filter. ■ The right and left filters are interchangeable.
1	<p>The Titanium apatite photocatalytic air-purifying filter ASSY is attached to the back of the air filter.</p> 	
2	<p>Remove the Titanium apatite photocatalytic air-purifying filter ASSY by bending the air filter and releasing the projections from the air filter frame.</p> 	
3	<p>Remove the Titanium apatite photocatalytic air-purifying filter from its frame (at 5 positions) by bending it.</p> 	

2. Removal of Front Panel

Procedure



Warning

Be sure to wait for 10 minutes or more after turning off all power supplies before disassembling work.

Step	Procedure	Points
1. Remove the front panel.		
1 Open the panel over the position where it stops.	<p>(R4312)</p>	
2 Slide the left rotary shaft to the right and release it.	<p>(R4313)</p>	
3 Slide the right rotary shaft to the left and release it.	<p>(R4315)</p>	
4 Remove the front panel.	<p>(R17126)</p>	<p>■ When reassembling the front panel, fit the right and left rotary shafts one by one into the grooves and fully push them into position.</p>

3. Removal of Front Grille

Procedure



Warning

Be sure to wait for 10 minutes or more after turning off all power supplies before disassembling work.

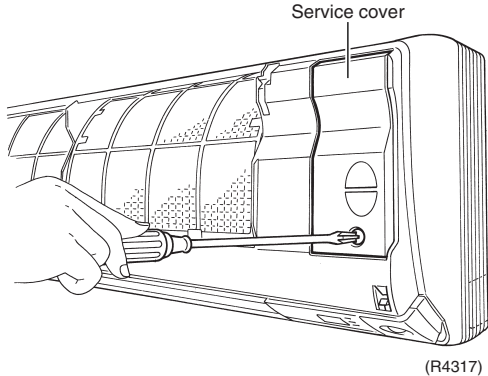
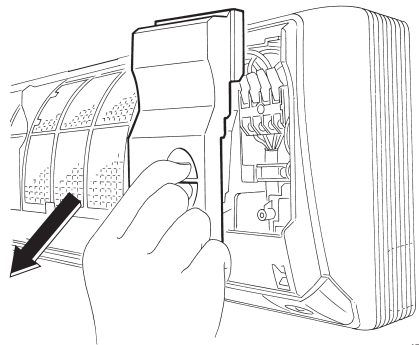
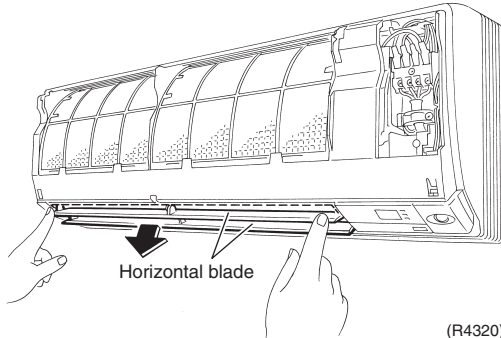
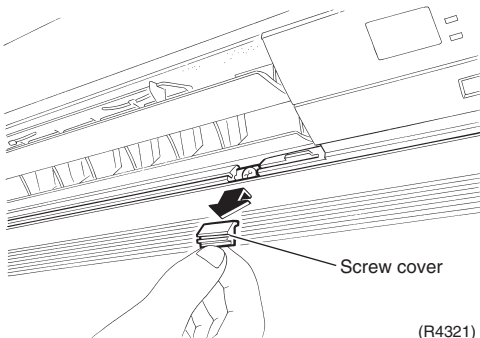
Step	Procedure	Points
1. Remove the service cover. 1 Remove the screw of the service cover. 2 Remove the service cover.	 <p>(R4317)</p>  <p>(R4318)</p>	Preparation <ul style="list-style-type: none"> ■ Remove the front panel according to the "Removal of Front Panel." ■ You can remove the front grille without detaching the service cover.
2. Remove the front grille. 1 Open the horizontal blades. 2 Remove the 2 screw covers.	 <p>(R4320)</p>  <p>(R4321)</p>	

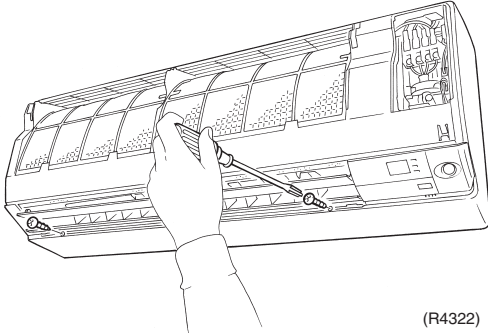
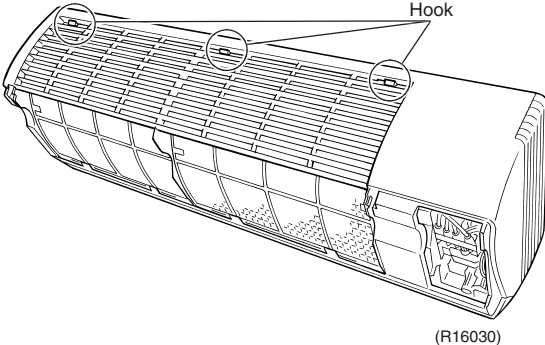
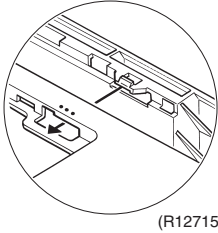
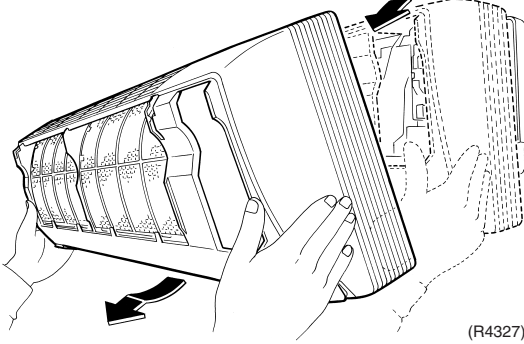
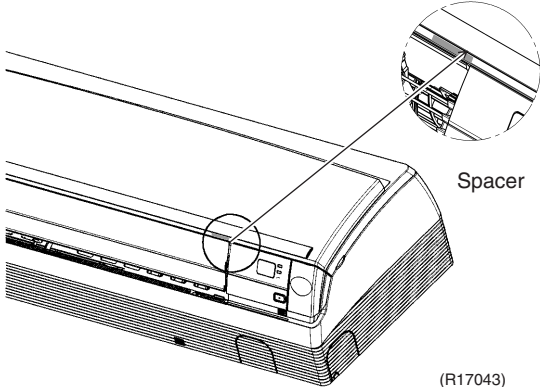
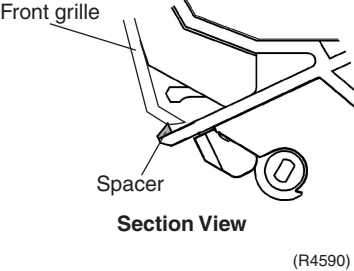
Step	Procedure	Points
3	Remove the 2 screws.	<ul style="list-style-type: none"> When reassembling the indoor unit, drive the screws with the horizontal blades open or removed.
4	Unfasten the 3 hooks at the top.	<ul style="list-style-type: none"> The convex marks (...) on the front panel indicate the position of the hooks.
5	Pull the upper part of the front grille out and lift the lower part up, and then remove the front grille.	<ul style="list-style-type: none"> When reassembling, make sure that all the 3 hooks are fastened as they were.
	 <p>(R4322)</p>	
	 <p>Hook</p> <p>(R16030)</p>	 <p>(R12715)</p>
	 <p>(R4327)</p>	<ul style="list-style-type: none"> When reassembling, be sure not to get it stuck on the spacer of the drain pan.
	 <p>Spacer</p> <p>(R17043)</p>	 <p>Front grille</p> <p>Spacer</p> <p>Section View</p> <p>(R4590)</p>

4. Removal of Horizontal Blades / Vertical Blades

Procedure



Warning

Be sure to wait for 10 minutes or more after turning off all power supplies before disassembling work.

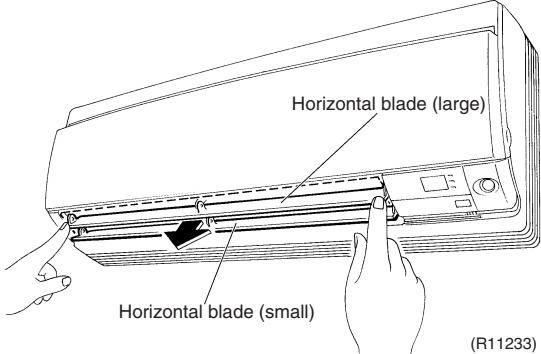
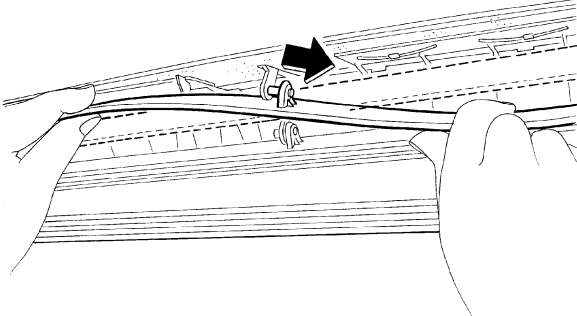
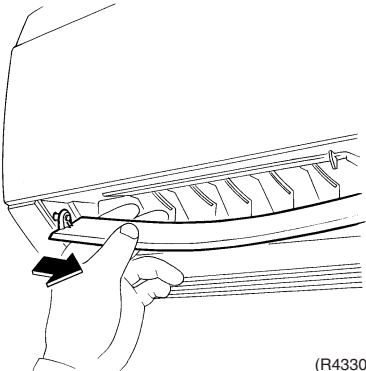
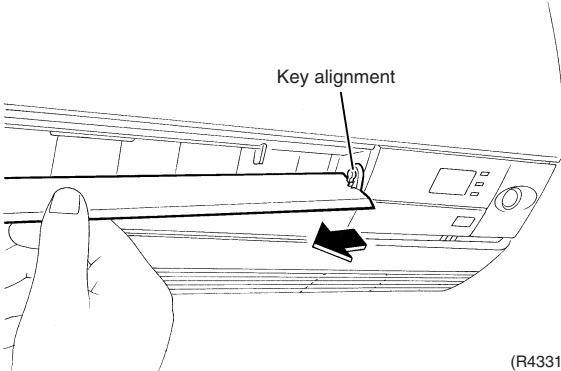
Step	Procedure	Points
1. Remove the horizontal blade (large).		
1	Open the horizontal blade (large).	
		
2	Unfasten the center shaft while bending the horizontal blade (large) slightly.	<ul style="list-style-type: none"> ■ When reassembling, mount the large horizontal blade to the upper position and the small horizontal blade to the lower position. Do not put them in the wrong place.
		
3	Unfasten the left shaft.	
		
4	Unfasten the right shaft.	<ul style="list-style-type: none"> ■ There is a key alignment at the right shaft. When reassembling, insert the right shaft first while turning. ■ After inserting the right shaft, mount the horizontal blade to the center shaft and then to the left shaft.
		

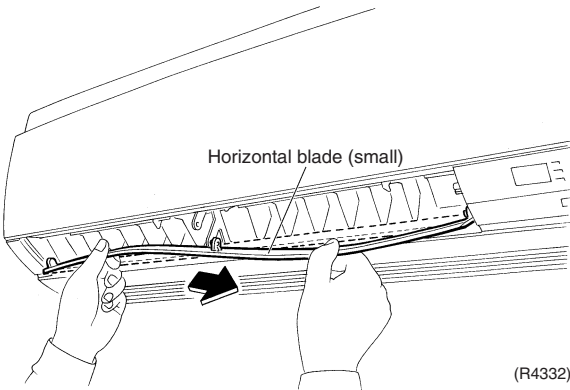
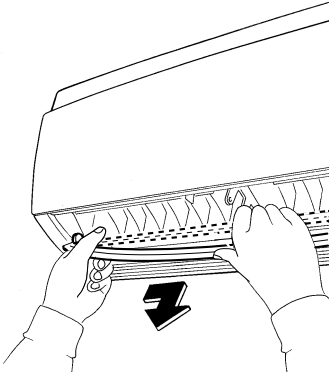
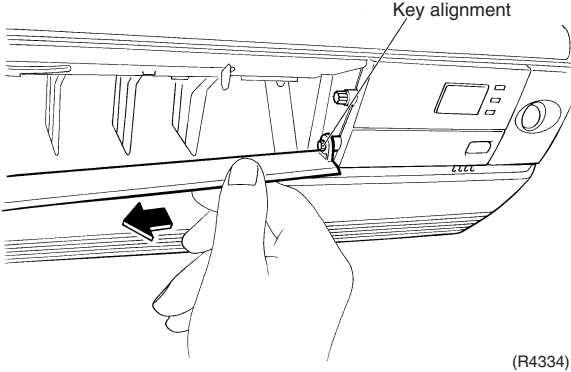
Step	Procedure	Points
2. Remove the horizontal blade (small).		
1	<p>Unfasten the center shaft while bending the horizontal blade (small) slightly.</p>  <p>(R4332)</p>	
2	<p>Unfasten the left shaft.</p>  <p>(R12716)</p>	
3	<p>Unfasten the right shaft.</p>  <p>(R4334)</p>	<ul style="list-style-type: none"> ■ There is a key alignment at the right shaft. When reassembling, insert the right shaft first while turning. ■ After inserting the right shaft, mount the horizontal blade to the center shaft and then to the left shaft.

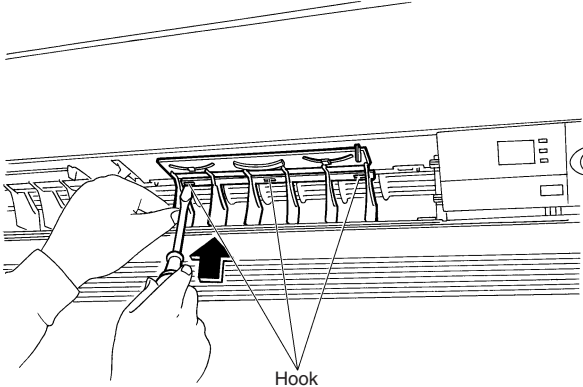
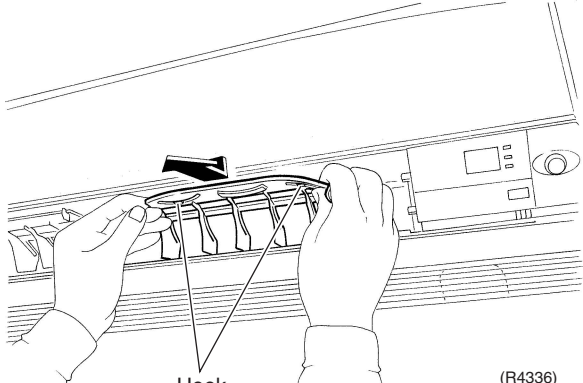
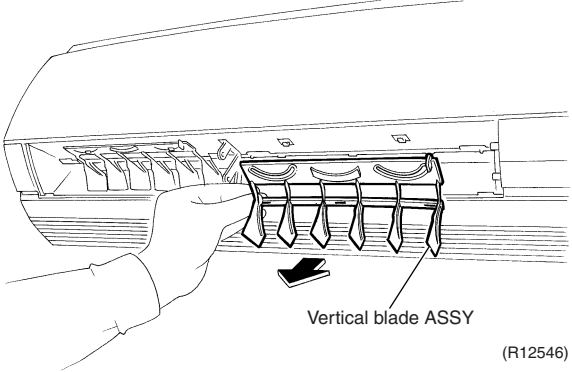
Step	Procedure	Points
3. Remove the vertical blade ASSY.		
1	<p>Unfasten the 3 hooks at the shaft mounting part by pressing them with a flat screwdriver.</p>  <p style="text-align: center;">Hook</p> <p style="text-align: right;">(R4335)</p>	
2	<p>Unfasten the hooks at the upper 2 positions.</p>  <p style="text-align: center;">Hook</p> <p style="text-align: right;">(R4336)</p>	
3	<p>Remove the vertical blade ASSY.</p>  <p style="text-align: center;">Vertical blade ASSY</p> <p style="text-align: right;">(R12546)</p>	<ul style="list-style-type: none"> ■ A vertical blade ASSY has 6 fins. It is impossible to replace only one fin. ■ The vertical blade ASSY is not marked for difference between right and left.

5. Removal of Electrical Box

Procedure



Warning

Be sure to wait for 10 minutes or more after turning off all power supplies before disassembling work.

Step	Procedure	Points
1	The figure shows the connections of wire harnesses.	<p>Preparation</p> <ul style="list-style-type: none"> Remove the front grille according to the "Removal of Front Grille."
2	Remove the screw of the wire fixture.	
3	Remove the 4 screws of the terminal board and disconnect the connecting wire.	
4	Disconnect the connector for the swing motor [S6].	<ul style="list-style-type: none"> Put any excess wires behind the power supply lead wire.

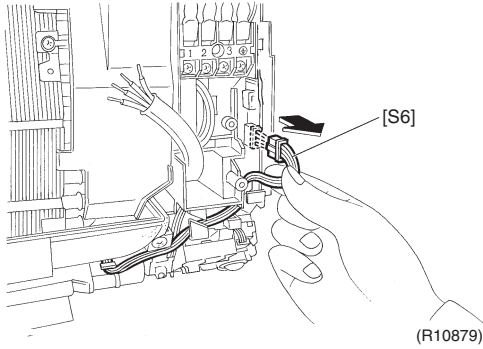
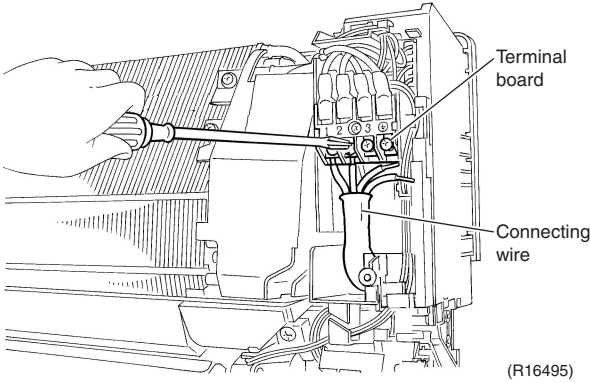
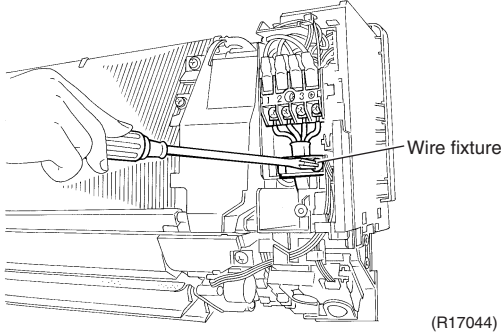
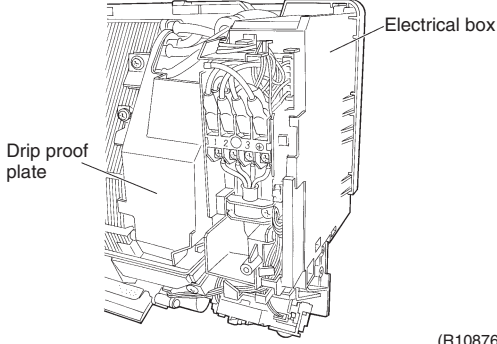

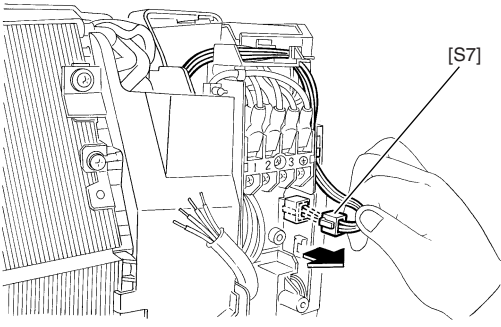
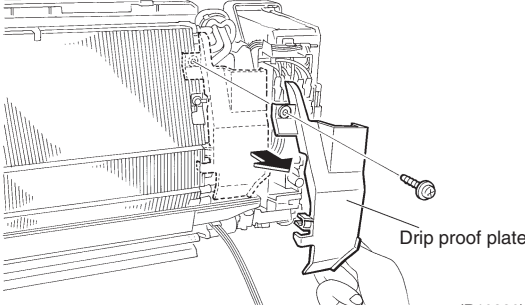
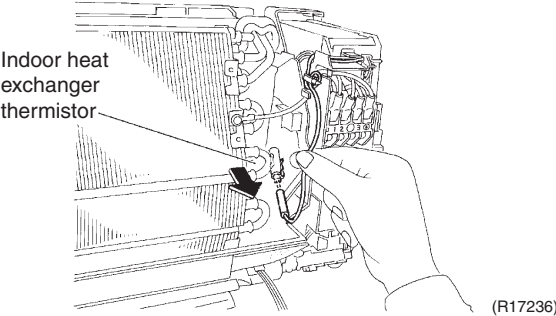
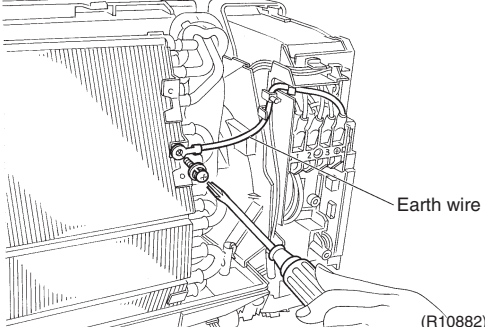
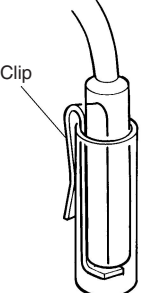
Step	Procedure	Points	
5	Disconnect the connector for the fan motor [S7].	 <p>(R11470)</p>	<ul style="list-style-type: none"> Some models have no harness for [S7].
6	Remove the screw and remove the drip proof plate.	 <p>Drip proof plate</p> <p>(R10880)</p>	
7	Pull out the indoor heat exchanger thermistor.	 <p>Indoor heat exchanger thermistor</p> <p>(R17236)</p>	<ul style="list-style-type: none"> Be careful not to lose the clip for the thermistor.
8	Remove the screw of the earth wire.	 <p>Earth wire</p> <p>(R10882)</p>	 <p>Clip</p> <p>(R11234)</p>

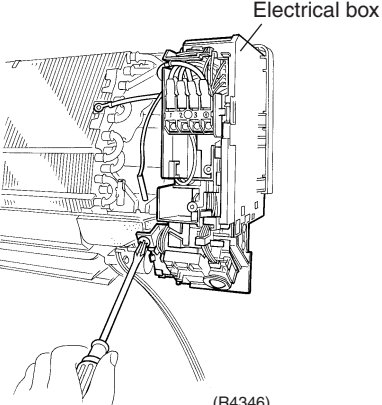
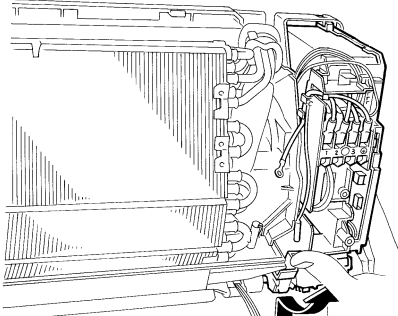
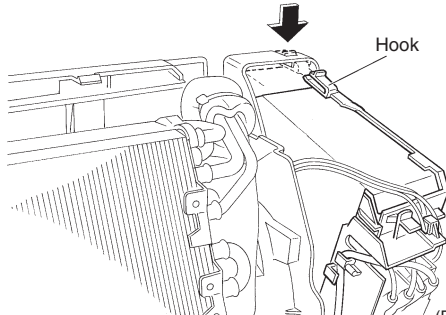
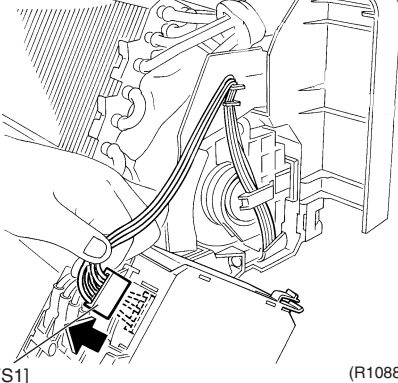
Step	Procedure	Procedure	Points
9	Remove the screw of the electrical box.	 <p>Electrical box</p> <p>(R4346)</p>	
10	Lift up and pull the electrical box.	 <p>(R10884)</p>	
11	Unfasten the hook at the upper far side by pressing it from above.	 <p>Hook</p> <p>(R10883)</p>	<ul style="list-style-type: none"> There is a hook also at the lower part of the back. When reassembling the electrical box, make sure that it is securely fastened.
12	Disconnect the connector for the fan motor [S1] and remove the electrical box.	 <p>[S1]</p> <p>(R10885)</p>	

6. Removal of PCBs

Procedure



Warning

Be sure to wait for 10 minutes or more after turning off all power supplies before disassembling work.

Step	Procedure	Points
<p>1. Remove the shield plate.</p> <p>1 The figure shows the appearance of the electrical box.</p> <p>2 Open the shield plate.</p> <p>3 Push the upper center of the shield plate and unfasten the 2 hooks. Remove the shield plate.</p>	<p>(R4350)</p> <p>(R13208)</p> <p>(R4352)</p>	<p>Preparation</p> <ul style="list-style-type: none"> Remove the electrical box according to the "Removal of Electrical Box."
<p>2. Release the indoor heat exchanger thermistor.</p> <p>1 Release the indoor heat exchanger thermistor and the earth wire from the hooks.</p>	<p>(R4353)</p>	

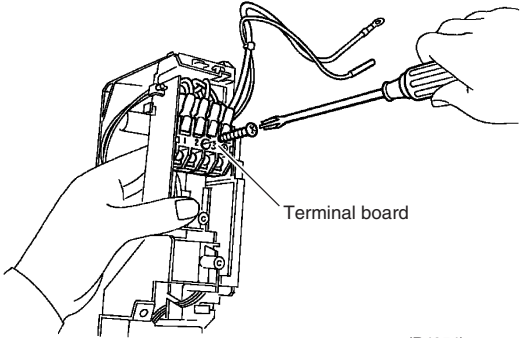
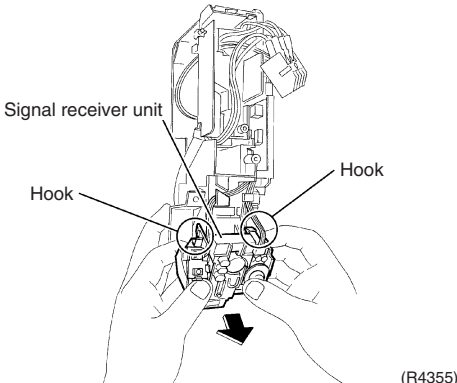
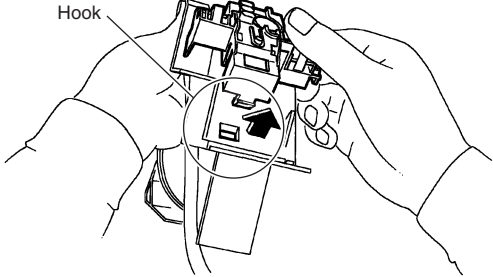
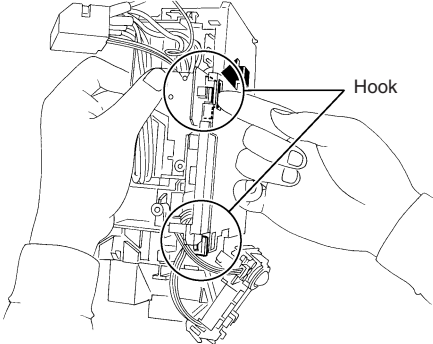
Step	Procedure	Points
3. Remove the terminal board.	<p data-bbox="204 286 467 376">1 Remove the screw and remove the terminal board.</p>  <p data-bbox="799 472 922 495">Terminal board</p> <p data-bbox="919 607 978 629">(R4354)</p>	
4. Remove the signal receiver unit.	<p data-bbox="204 723 459 813">1 Unfasten the 3 hooks and remove the signal receiver unit.</p>  <p data-bbox="564 786 719 808">Signal receiver unit</p> <p data-bbox="592 869 639 891">Hook</p> <p data-bbox="900 846 948 869">Hook</p> <p data-bbox="963 1055 1023 1077">(R4355)</p> <p data-bbox="204 1350 451 1384">2 Unfasten the 2 hooks.</p>  <p data-bbox="592 1093 639 1115">Hook</p> <p data-bbox="963 1379 1023 1402">(R12725)</p>  <p data-bbox="927 1503 975 1525">Hook</p> <p data-bbox="999 1783 1058 1805">(R16033)</p>	

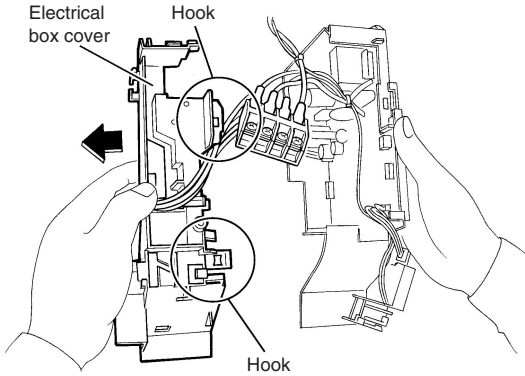
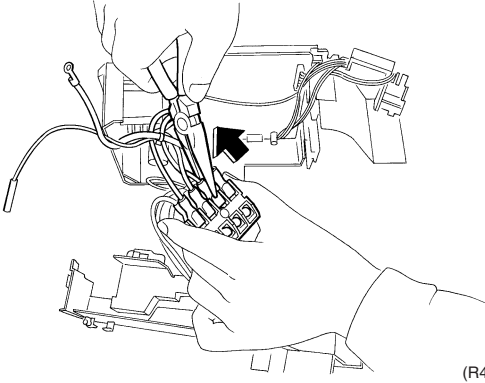
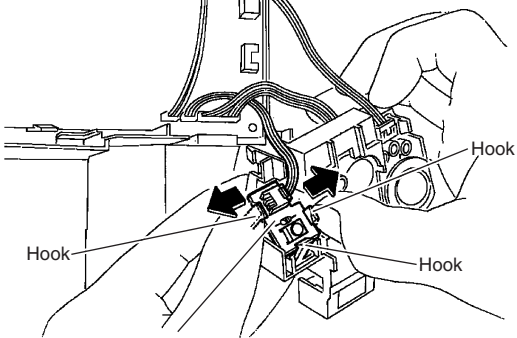
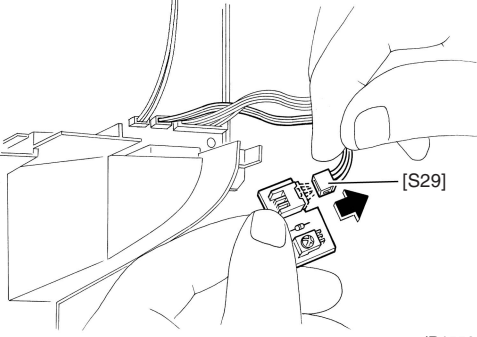
Step	Procedure	Points
3	<p>Slide the electrical box cover to the left and remove it.</p>  <p>(R4358)</p>	
4	<p>Disconnect the wire harnesses.</p>  <p>(R4359)</p>	
5.	<p>Remove the signal receiver PCB.</p>	
1	<p>Unfasten the 3 hooks and remove the signal receiver PCB.</p>  <p>(R4361)</p>	
2	<p>Disconnect the connector [S29] from the signal receiver PCB.</p>  <p>(R15506)</p>	

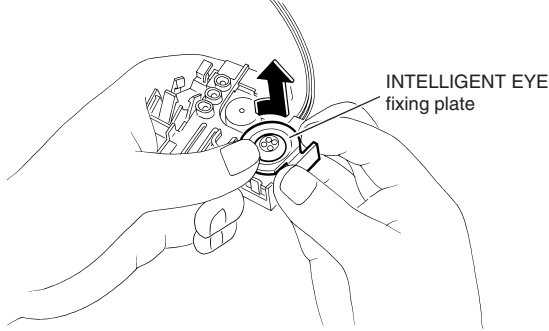
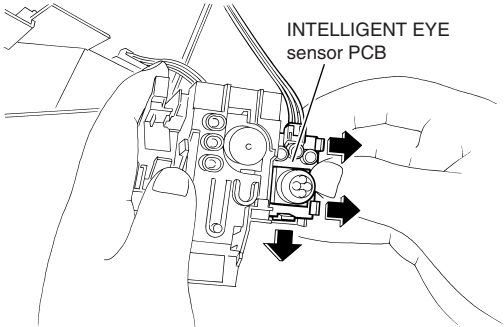
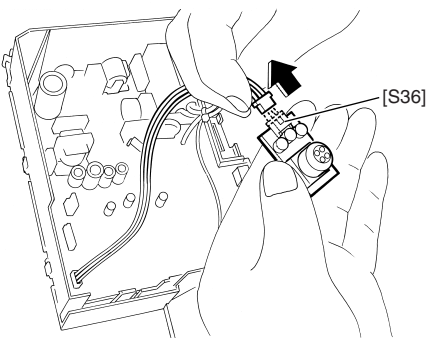
Step	Procedure	Points
6.	Remove the INTELLIGENT EYE sensor PCB.	<ul style="list-style-type: none"> Some models have no INTELLIGENT EYE sensor PCB.
1	Remove the INTELLIGENT EYE fixing plate by twisting it.	 <p>(R4363)</p>
2	Unfasten the right 3 hooks and remove the INTELLIGENT EYE sensor PCB. There are also 2 hooks on the left side.	 <p>(R4364)</p>
3	Disconnect the connector [S36] from the INTELLIGENT EYE sensor PCB.	 <p>(R4365)</p>

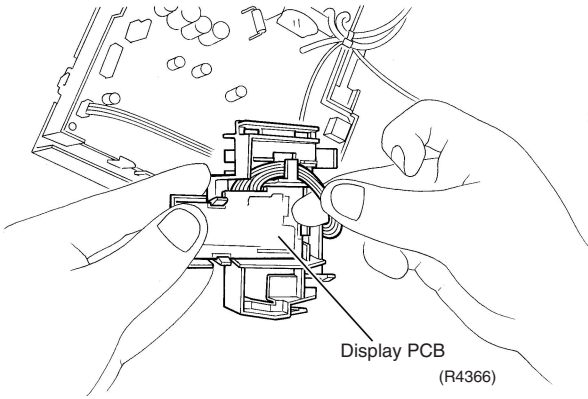
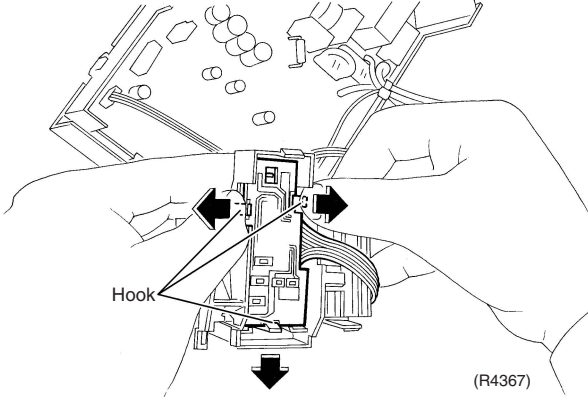
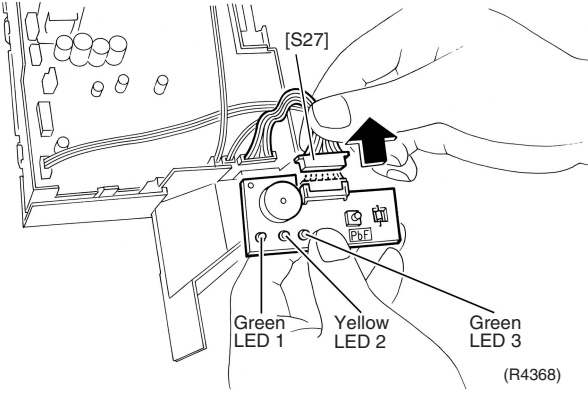
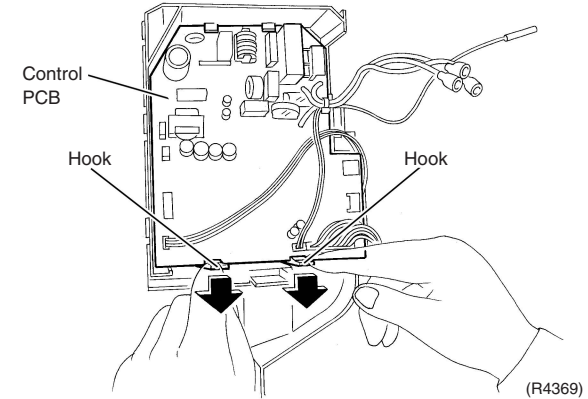
Step	Procedure	Points
<p>7. Remove the display PCB.</p> <p>1 The figure shows the connection of wire harness for the display PCB.</p> <p>2 Unfasten the 3 hooks and remove the display PCB.</p> <p>3 Disconnect the connector [S27] from the display PCB.</p>	 <p>Display PCB (R4366)</p>  <p>Hook</p> <p>(R4367)</p>  <p>[S27]</p> <p>Green LED 1 Yellow LED 2 Green LED 3</p> <p>(R4368)</p>	<ul style="list-style-type: none"> ■ The display PCB is located at the back of the signal receiver unit.
<p>8. Remove the control PCB.</p> <p>1 Unfasten the 2 lower hooks.</p>	 <p>Control PCB</p> <p>Hook Hook</p> <p>(R4369)</p>	

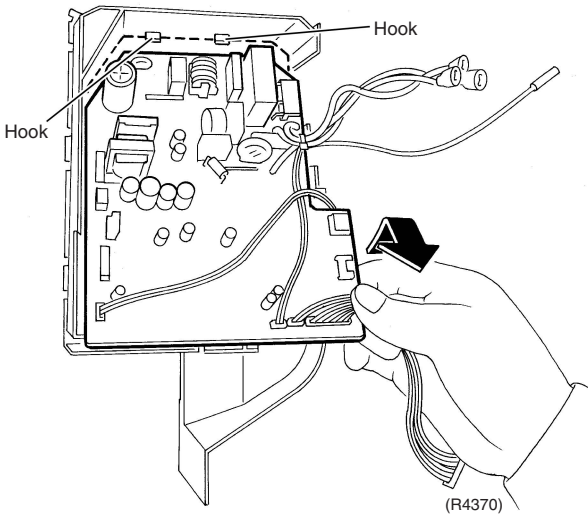
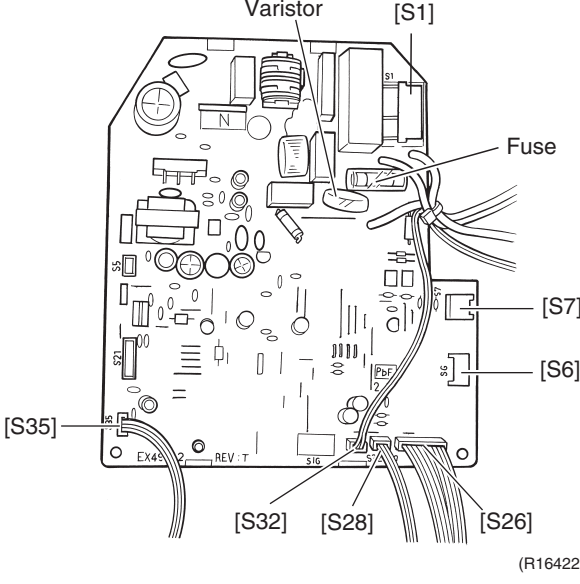
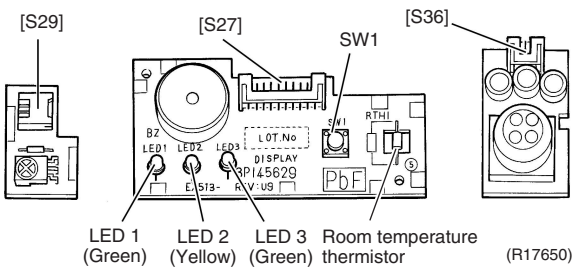
Step	Procedure	Points
2	<p>Lift up the bottom of the control PCB and pull it out.</p> 	<ul style="list-style-type: none"> When reassembling the control PCB, make sure that it is fixed by 2 upper hooks.
3	<p>The figures show the names of the PCB component parts.</p>  	<ul style="list-style-type: none"> [S1]: fan motor [S6]: swing motor [S7]: fan motor (Hall IC) [S26]: display PCB [S27]: control PCB [S28]: signal receiver PCB [S29]: control PCB [S32]: indoor heat exchanger thermistor [S35]: INTELLIGENT EYE sensor PCB [S36]: control PCB <ul style="list-style-type: none"> Some models have no harness for [S7], [S35].

7. Removal of Drain Pan Unit / Swing Motor

Procedure



Warning

Be sure to wait for 10 minutes or more after turning off all power supplies before disassembling work.

Step	Procedure	Points
1. Remove the drain pan unit.	<p>(R4374)</p>	Preparation <ul style="list-style-type: none"> ■ Remove the electrical box according to the "Removal of Electrical Box." ■ Inserting of the wooden base facilitates the removing work. ■ Place a plastic sheet under the drain pan to prevent from wetting the floor with remaining drain.
2. Remove the screw at the right side of the drain pan unit.	<p>(R4375)</p>	
3. Press the right side of the drain pan unit and twist the left side.	<p>(R4376)</p> <p>(R4377)</p>	

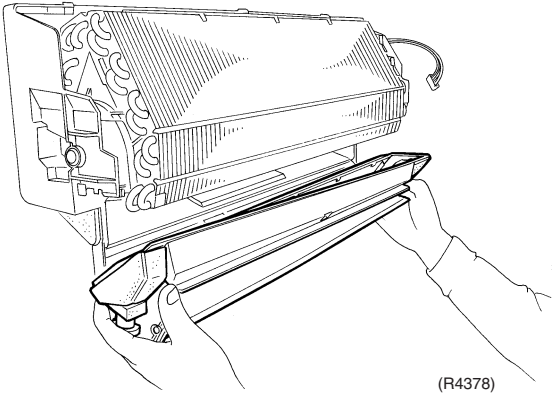
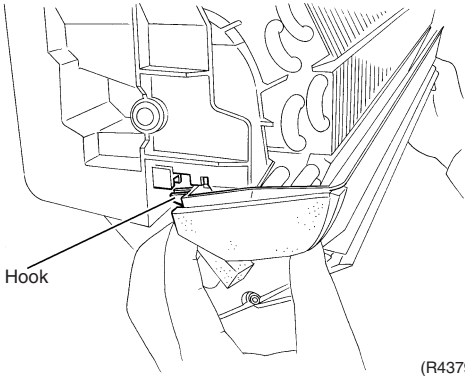
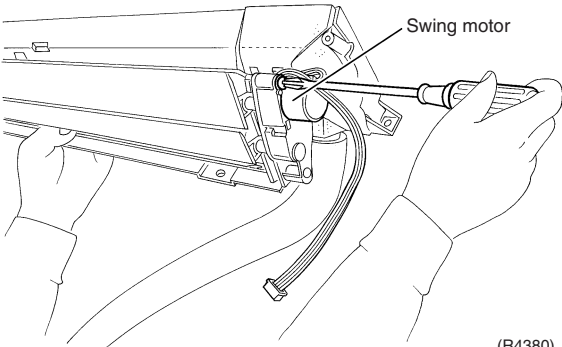
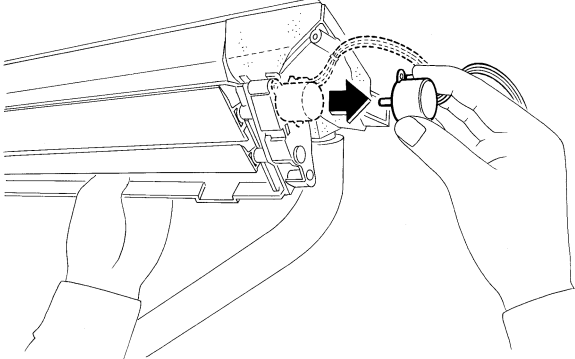
Step	Procedure	Points
<p>4</p>	<p>Remove the drain pan unit from the indoor unit.</p>  <p>(R4378)</p>  <p>Hook</p> <p>(R4379)</p>	<ul style="list-style-type: none"> ■ When reassembling, make sure that the hook at the left side is fitted in the groove.
<p>2. Remove the swing motor.</p>	<p>1 Remove the screw of the swing motor.</p>  <p>Swing motor</p> <p>(R4380)</p> <p>2 Pull out the swing motor.</p>  <p>(R4381)</p>	

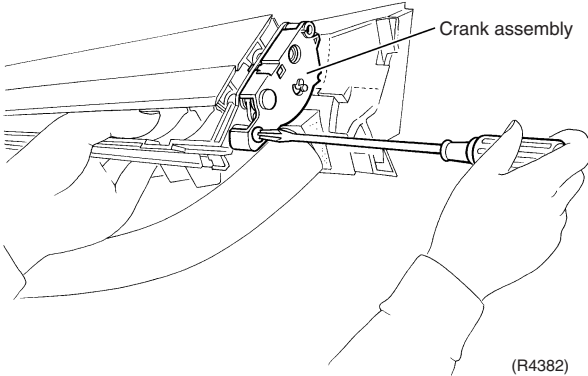
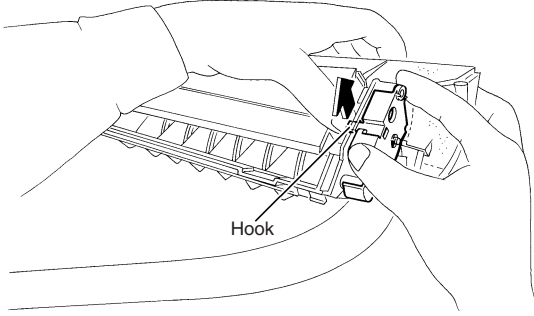
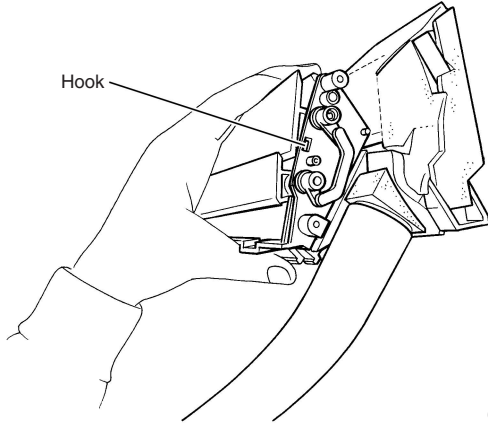
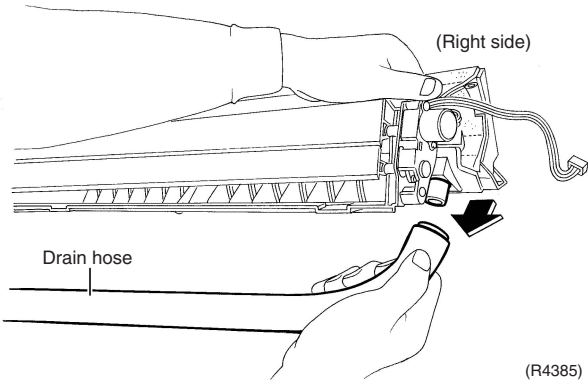
Step	Procedure	Points
<p>3. Remove the crank assembly.</p>	<p>1 Remove the screw of the crank assembly.</p>  <p>(R4382)</p> <p>2 Unfasten the hook and remove the crank assembly.</p>  <p>(R4383)</p> <p>3 The figure shows the position of the hook when the crank assembly has been removed.</p>  <p>(R4384)</p>	
<p>4. How to change the drain hose to the right piping</p>	<p>1 Pull out the drain hose from its right side connection.</p>  <p>(R4385)</p>	

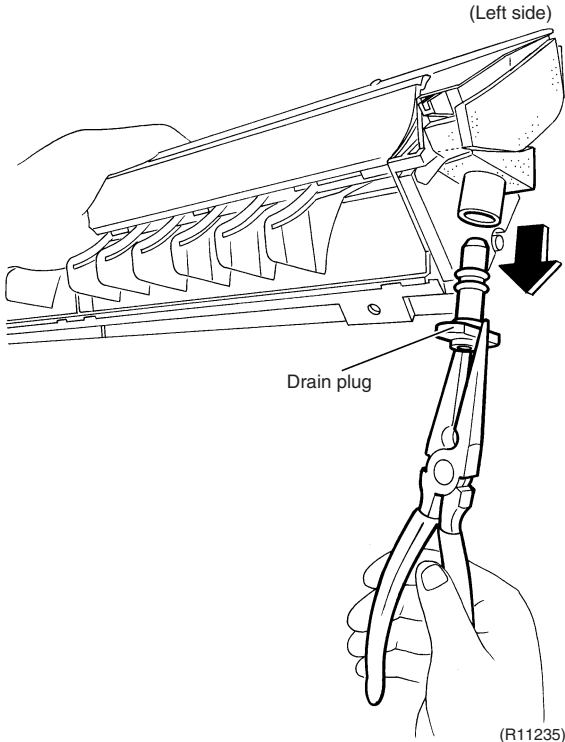
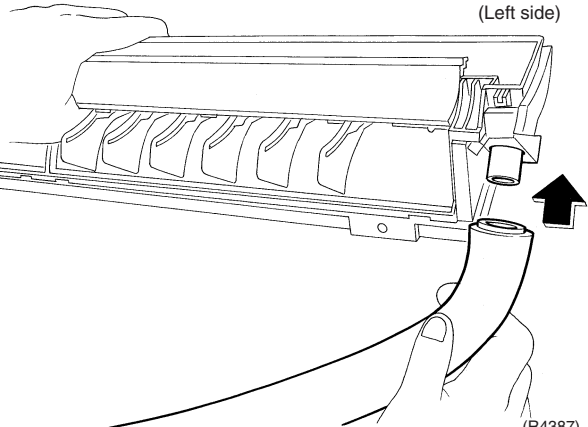
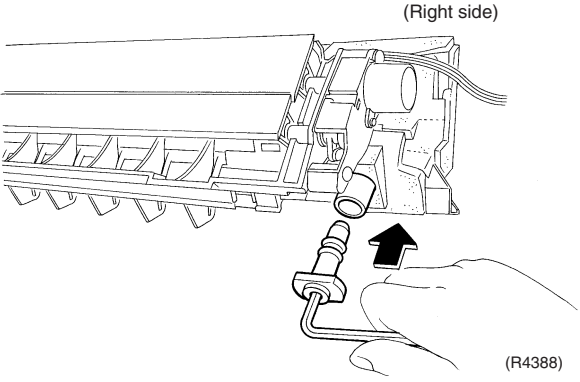
Step	Procedure	Points
2	<p>Remove the drain plug located at the left side of the drain pan unit.</p>  <p>(Left side)</p> <p>Drain plug</p> <p>(R11235)</p>	
3	<p>Insert the drain hose to the left side.</p>  <p>(Left side)</p> <p>(R4387)</p>	
4	<p>Insert the removed drain plug into the right side with a hexagonal wrench (4 mm).</p>  <p>(Right side)</p> <p>(R4388)</p>	<p>Caution Do not thrust the drain plug in with a sharp-pointed tool like a screwdriver. (The drain plug may be broken, resulting in water leakage.)</p>

8. Removal of Fan Motor

Procedure



Warning

Be sure to wait for 10 minutes or more after turning off all power supplies before disassembling work.

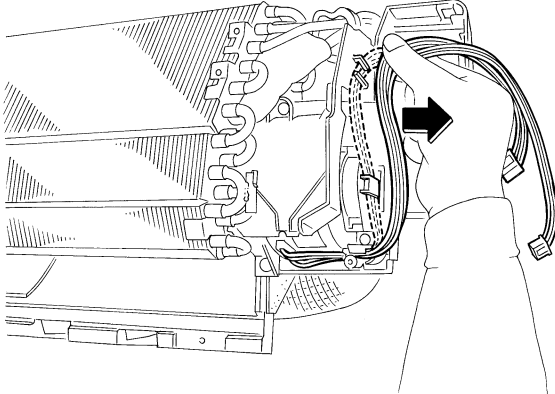
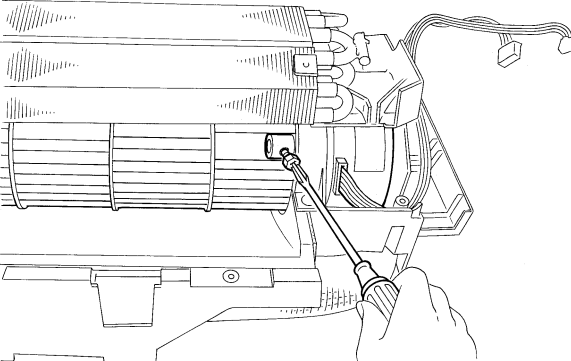
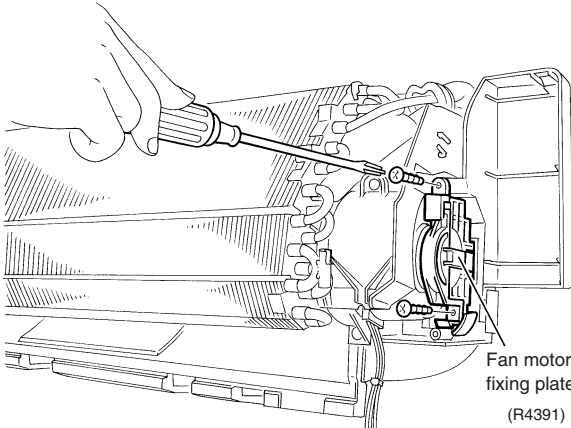
Step	Procedure	Procedure	Points
1	Release the fan motor lead wires from the hooks.	 <p style="text-align: right;">(R4389)</p>	Preparation <ul style="list-style-type: none"> ■ Remove the drain pan unit according to the "Removal of Drain Pan Unit / Swing Motor." ■ You can remove the fan motor with the indoor heat exchanger left.
2	Loosen the screw of the fan rotor.	 <p style="text-align: right;">(R15455)</p>	
3	Remove the 2 screws of the fan motor fixing plate.	 <p style="text-align: right;">Fan motor fixing plate (R4391)</p>	

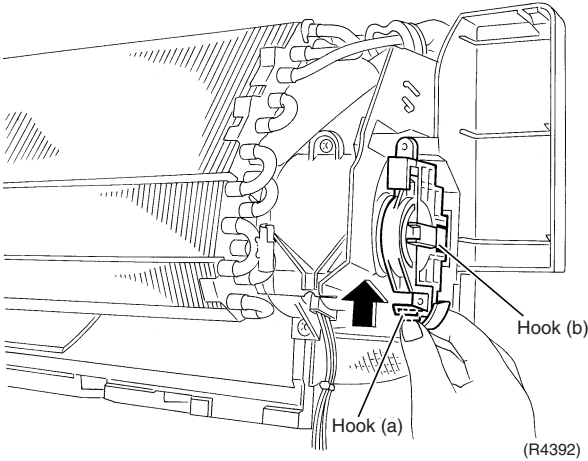
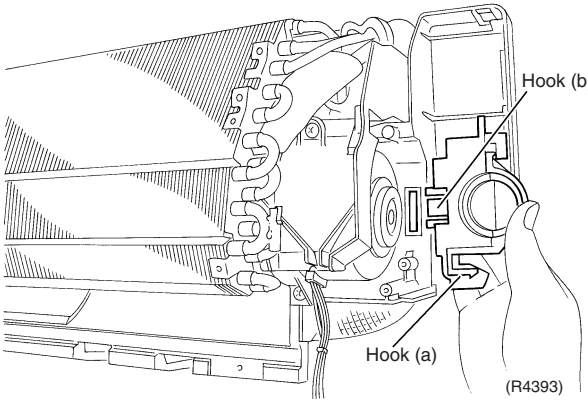
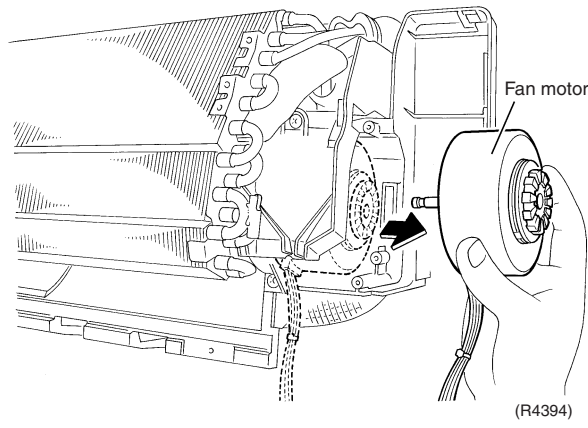
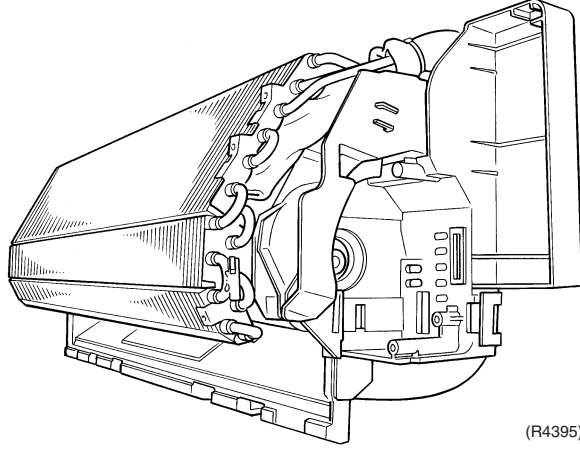
Step	Procedure	Points
4	<p>Unfasten the hook (a) of the fan motor fixing plate.</p>  <p>Hook (a)</p> <p>Hook (b)</p> <p>(R4392)</p>	
5	<p>Unfasten the hook (b) and remove the fan motor fixing plate.</p>  <p>Hook (a)</p> <p>Hook (b)</p> <p>(R4393)</p>	
6	<p>Remove the fan motor.</p>  <p>Fan motor</p> <p>(R4394)</p>  <p>(R4395)</p>	

9. Removal of Indoor Heat Exchanger

Procedure



Warning

Be sure to wait for 10 minutes or more after turning off all power supplies before disassembling work.

Step	Procedure	Points
1. Disconnect the refrigerant piping.	<p>(R4396)</p>	<p>Preparation</p> <ul style="list-style-type: none"> Remove the drain pan unit according to the "Removal of Drain Pan Unit / Swing Motor." <p>Caution From the viewpoint of global environmental protection, make sure to use a vacuum pump for air purging.</p>
2. Lift the indoor unit with a wooden base.	<p>(R4397)</p>	<p>Caution In pump-down work, be sure to stop the compressor before disconnecting the refrigerant pipe. If the refrigerant pipe is disconnected with the compressor operating and the stop valve open, air may be sucked in and may generate an over-pressure in refrigeration cycle, thus resulting in pipe rupture or accidental injury.</p>
3. Pull out the drain hose. (In the case of left piping)	<p>Drain hose</p> <p>(R4398)</p>	<ul style="list-style-type: none"> Place a plastic sheet under the drain pan to prevent from wetting the floor with remaining drain. If the drain hose is embedded in the wall, disconnect the drain hose beforehand.
4. Disconnect the pipings.	<p>(R4399)</p>	<ul style="list-style-type: none"> Carry out the removal work with 2 wrenches. When the pipings are disconnected, protect both the openings of pipe and unit from entering of moisture.

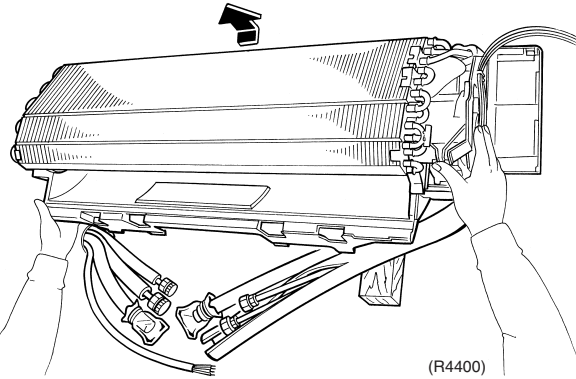
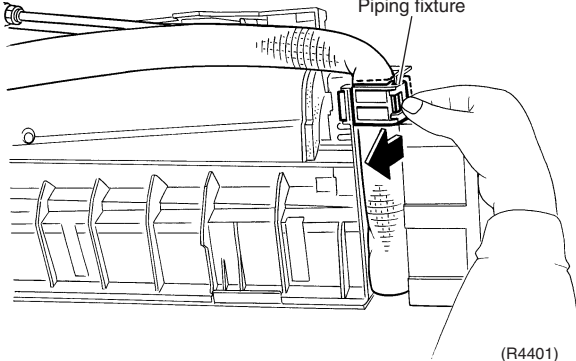
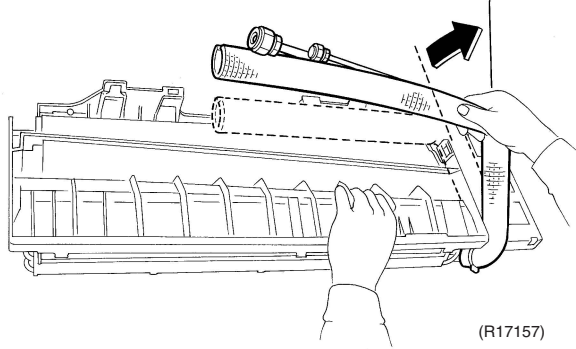
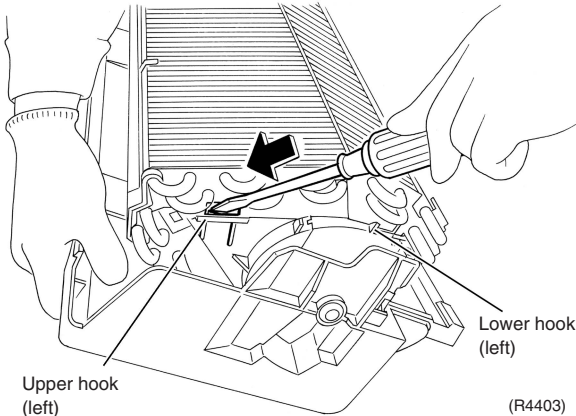
Step	Procedure	Points
<p>2. Remove the indoor unit.</p>	<p>1 Remove the indoor unit from the installation plate.</p>  <p>(R4400)</p>	
<p>3. Remove the indoor heat exchanger.</p>	<p>1 Unfasten the hook of the piping fixture at the back of the unit and pull out the pipe.</p>  <p>(R4401)</p> <p>2 Slightly widen the auxiliary piping.</p>  <p>(R17157)</p> <p>3 Unfasten the upper hook (left) with a flat screwdriver.</p>  <p>(R4403)</p>	<p>Caution When removing or reassembling the indoor heat exchanger, be sure to wear gloves or wrap the indoor heat exchanger with cloths. (You may be injured by the fins.)</p>

Step	Procedure	Points
4	Unfastening the lower left hook, hold up the indoor heat exchanger by its left side and lift it up.	<ul style="list-style-type: none"> ■ When reassembling the indoor heat exchanger, make sure that the hook (left) is fastened.
5	When the left side is lifted, the 2 hooks at the right side comes off position.	
6	Remove the indoor heat exchanger.	

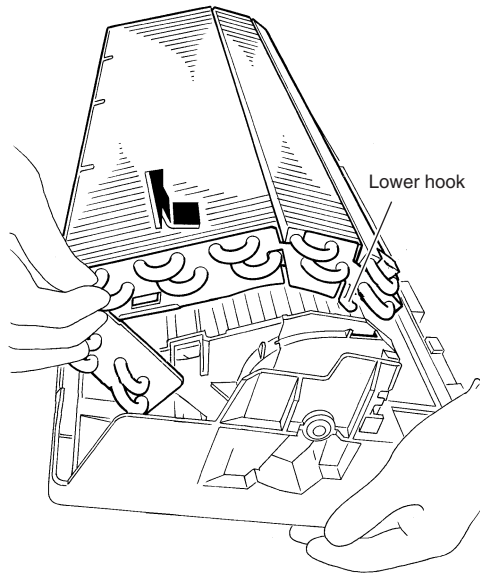

(R17045)

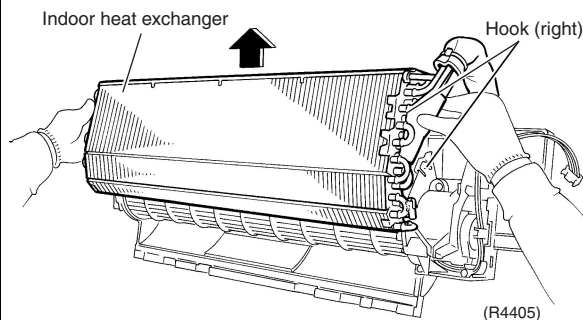

(R4405)

10. Removal of Fan Rotor

Procedure



Warning

Be sure to wait for 10 minutes or more after turning off all power supplies before disassembling work.

Step	Procedure	Points
1. Remove the right side plate.	<p style="text-align: right;">Right side plate</p> <p style="text-align: right;">(R4406)</p>	<p>Preparation</p> <ul style="list-style-type: none"> Remove the indoor heat exchanger according to the "Removal of Indoor Heat Exchanger."
1 Remove the 2 screws of the right side plate.	<p style="text-align: right;">(R4407)</p>	
2 Release the fan motor lead wires from the hooks and remove the right side plate.	<p style="text-align: right;">(R4408)</p>	
3 Remove the 2 screws of the fan motor fixing plate.	<p style="text-align: right;">Fan motor fixing plate</p> <p style="text-align: right;">(R4409)</p>	

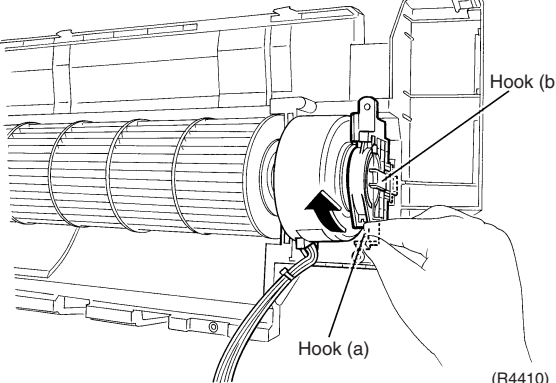
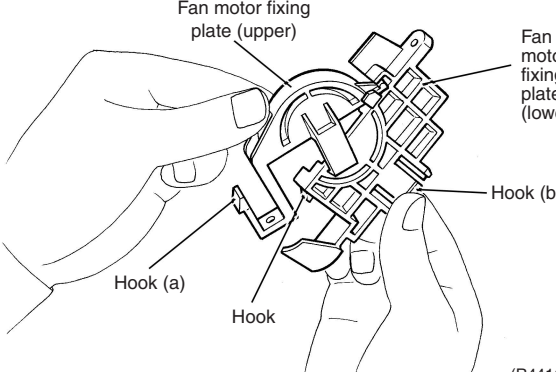
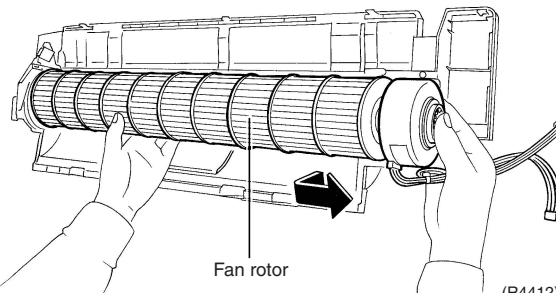
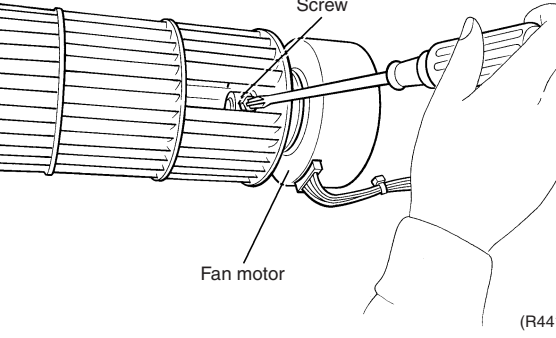
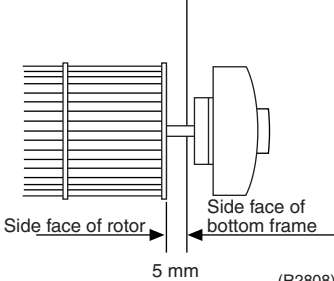
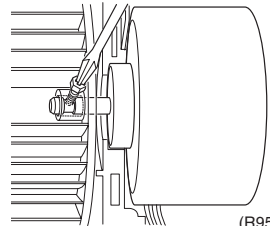
Step	Procedure	Points
4	Unfasten the hook (a) of the fan motor fixing plate and unfasten the hook (b).	 <p style="text-align: right;">(R4410)</p>  <p style="text-align: right;">(R4411)</p>
2. Remove the fan rotor.	<p data-bbox="199 1064 474 1131">1 Slide the fan rotor to the right.</p> <p data-bbox="199 1444 474 1512">2 Loosen the screw and remove the fan motor.</p>	<p data-bbox="1093 1030 1460 1198">■ When reassembling the fan motor and the fan rotor, provide as much as 5 mm of play between the side face of the rotor and the bottom frame.</p>  <p style="text-align: right;">(R4412)</p>  <p style="text-align: right;">(R4413)</p>  <p style="text-align: right;">(R2808)</p>  <p style="text-align: right;">(R9582)</p> <ol data-bbox="1093 1747 1460 2116" style="list-style-type: none"> (1) Insert the fan motor with approx. 5 mm left. (2) Tighten the screw until it stops. Then turn the screw in one scroll. (3) Move the fan rotor and confirm the fan motor and the fan rotor are installed appropriately. (4) Tighten the screw completely if appropriate. (5) If not appropriate, go back to (1).

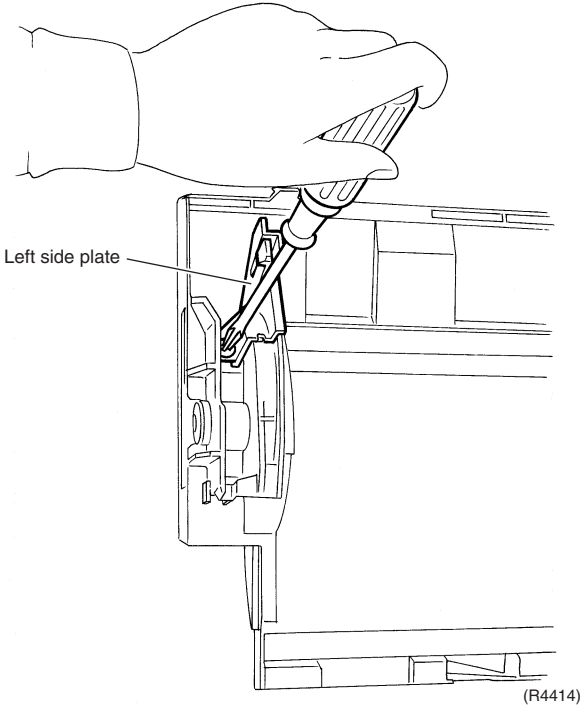
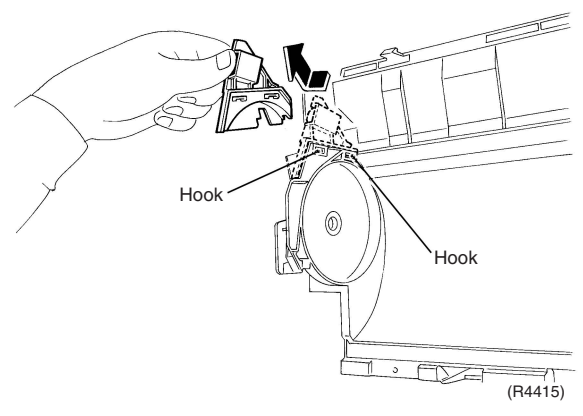
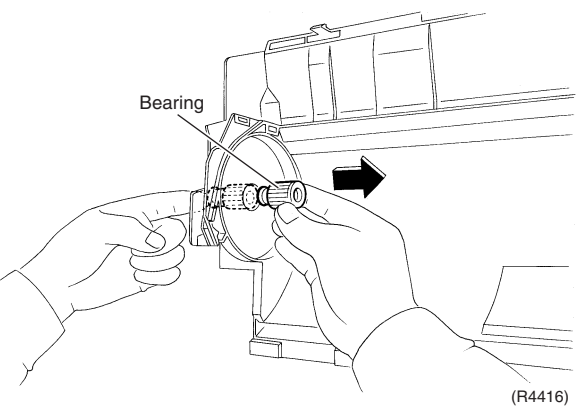
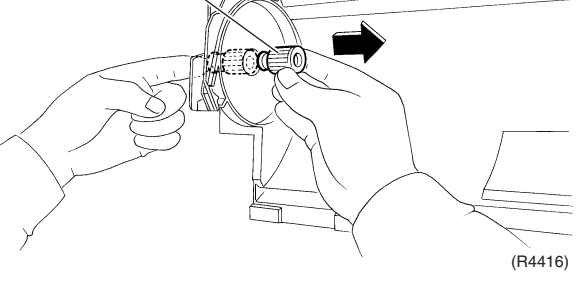
Step	Procedure	Points
3.	Remove the bearing.	
1	<p>Remove the screw of the left side plate.</p>  <p>Left side plate</p> <p>(R4414)</p>	
2	<p>Unfasten the 2 hooks and remove the left side plate.</p>  <p>Hook</p> <p>Hook</p> <p>(R4415)</p>	
3	<p>Press the bearing from outside.</p>  <p>Bearing</p> <p>(R4416)</p>	
4	<p>Remove the bearing.</p>  <p>(R4416)</p>	

Revision History

Month / Year	Version	Revised contents
02 / 2013	Si04-951	First edition

Warning



- Daikin products are manufactured for export to numerous countries throughout the world. Prior to purchase, please confirm with your local authorised importer, distributor and/or retailer whether this product conforms to the applicable standards, and is suitable for use, in the region where the product will be used. This statement does not purport to exclude, restrict or modify the application of any local legislation.
- Ask a qualified installer or contractor to install this product. Do not try to install the product yourself. Improper installation can result in water or refrigerant leakage, electrical shock, fire or explosion.
- Use only those parts and accessories supplied or specified by Daikin. Ask a qualified installer or contractor to install those parts and accessories. Use of unauthorised parts and accessories or improper installation of parts and accessories can result in water or refrigerant leakage, electrical shock, fire or explosion.
- Read the User's Manual carefully before using this product. The User's Manual provides important safety instructions and warnings. Be sure to follow these instructions and warnings.

If you have any enquiries, please contact your local importer, distributor and/or retailer.

Cautions on product corrosion

1. Air conditioners should not be installed in areas where corrosive gases, such as acid gas or alkaline gas, are produced.
2. If the outdoor unit is to be installed close to the sea shore, direct exposure to the sea breeze should be avoided. If you need to install the outdoor unit close to the sea shore, contact your local distributor.

Dealer

DAIKIN INDUSTRIES, LTD.

Head Office:
Umeda Center Bldg., 2-4-12, Nakazaki-Nishi,
Kita-ku, Osaka, 530-8323 Japan

Tokyo Office:
JR Shinagawa East Bldg., 2-18-1, Konan,
Minato-ku, Tokyo, 108-0075 Japan

http://www.daikin.com/global_ac/

©All rights reserved