



Si04-754

# REMOVAL PROCEDURE



S E R V I C E M A N U A L

**5.0/6.0/7.1 kW Class**

**15000/18000/24000 Btu/h Class**



Indoor Unit



Inverter / Non-Inverter



Wall Mounted Type



# **Service Manual Removal Procedure**

## **Indoor Unit**

### **●Cooling Only**

**FTE18GV2S**

**FTKD50BVMD**

**FTKD60BVMD**

**FTKD71BVMD**

### **●Heat Pump**

**FTXS15DVJU**

**FTXS18DVJU**

**FTXS24DVJU**

# Table of Contents

1. Removal of Air Filters / Front Panel .....	2
2. Removal of Front Grille .....	5
3. Removal of Horizontal Blades / Vertical Blades .....	7
4. Removal of Electrical Box .....	9
5. Removal of PCBs .....	11
6. Removal of Swing Motors .....	14
7. Removal of Indoor Heat Exchanger .....	16
8. Removal of Fan Rotor / Fan Motor .....	19
9. Exchange of Drain Hose (Piping Direction).....	21



**Note:**

- ♦ The illustrations may be slightly different depending on the model.

# 1. Removal of Air Filters / Front Panel

**Procedure**

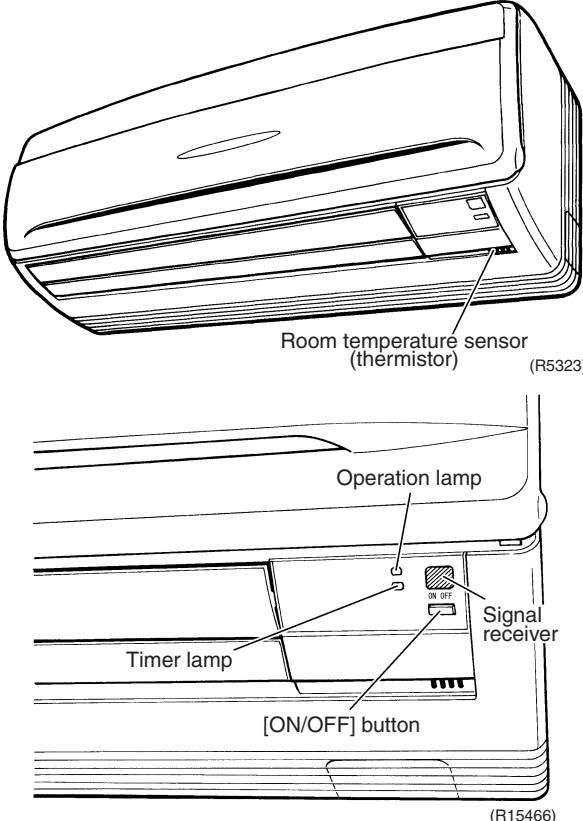
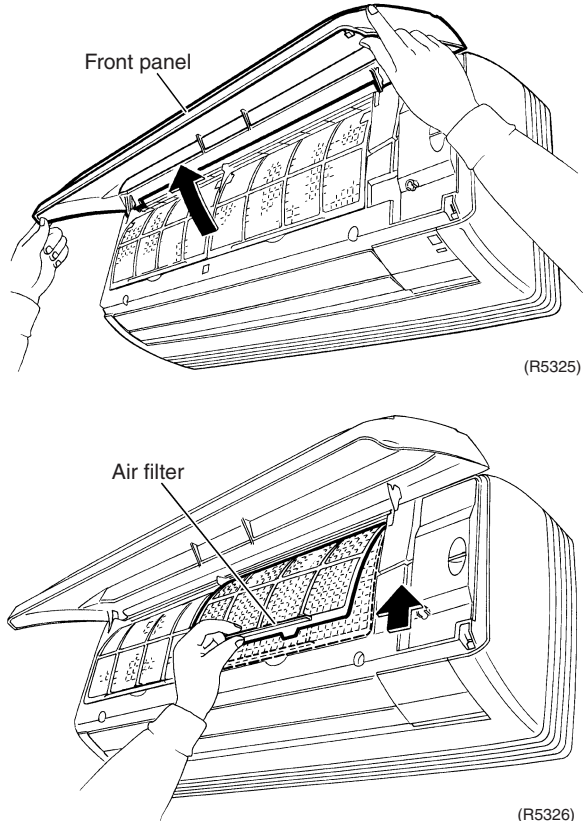

**Warning** Be sure to wait for 10 minutes or more after turning off all power supplies before disassembling work.

Step	Procedure	Points
<p>1. Appearance features</p>		<p><b>Warning</b>  <b>Dangerous: High voltage</b>                  A high voltage is applied to all the electric circuits of this product including thermistors.</p> <ul style="list-style-type: none"> <li>■ When the signal receiver catches a signal from the remote controller, the receiving tone sounds and the operation lamp blinks immediately to confirm the signal reception.</li> <li>■ When the [ON/OFF] button is kept pressed for 5 seconds, the forced cooling operation is performed for about 15 minutes.</li> </ul>
<p>2. Remove the air filters.</p> <p>1 Open the front panel to the position where it stops.</p> <p>2 Lift the air filter upward slightly by the center knob, and then pull it out downward.</p>		<ul style="list-style-type: none"> <li>■ The air filter is not marked for difference between the right and left sides.</li> <li>■ Insert the air filter with the "FRONT" mark faced up.</li> <li>■ The air filter can be set easily by inserting it along the guides.</li> <li>■ Be sure to insert the hooks (at 2 lower positions) when mounting the air filter.</li> </ul>

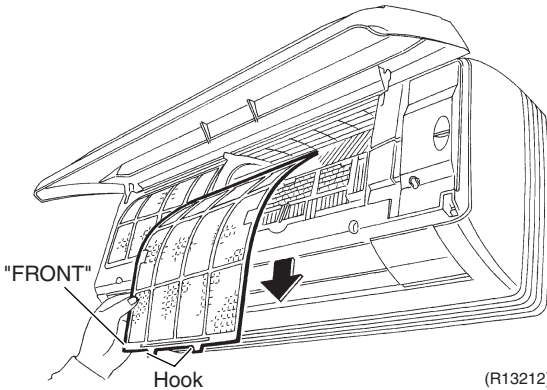
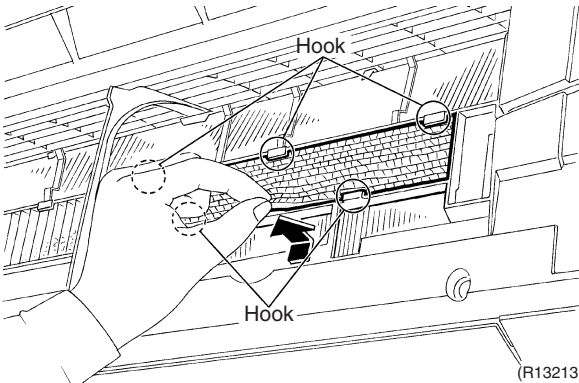
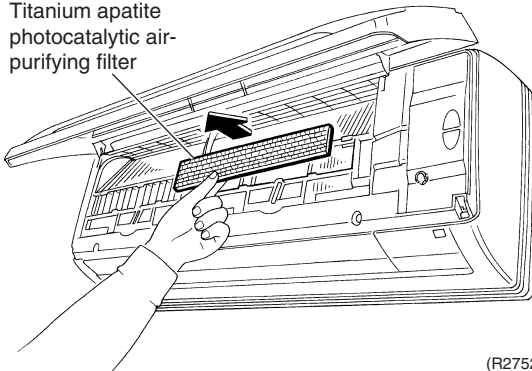
Step	Procedure	Points
3	Pull out the air filter downward.	<ul style="list-style-type: none"> <li>■ The right and left filters are interchangeable.</li> <li>■ Insert the air filters along grooves when installing.</li> <li>■ Insert the 2 hooks of the air filter completely.</li> </ul>
 <p style="text-align: right;">(R13212)</p>		
<p>3. Remove the Titanium apatite photocatalytic air-purifying filters.</p>		<ul style="list-style-type: none"> <li>■ The right and left filters are interchangeable.</li> </ul>
1	Push up the bottom of a Titanium apatite photocatalytic air-purifying filter to unfasten the hooks (2 on lower, 3 on upper) and take the filter out.	
 <p style="text-align: right;">(R13213)</p>		
 <p style="text-align: right;">(R2752)</p>		

Step	Procedure	Points
4. Remove the front panel.	<p>1 While opening the front panel further than where it stops, release both the shafts and remove the front panel.</p>	<ul style="list-style-type: none"> <li>■ Slide the front panel side to side to release each shaft.</li> <li>■ When reassembling the front panel, fit the right and left rotary shafts one by one into the grooves and fully push them in position.</li> </ul>

## 2. Removal of Front Grille

### Procedure



**Warning** Be sure to wait for 10 minutes or more after turning off all power supplies before disassembling work.

Step	Procedure	Points
1. Remove the service cover.	<p>Service cover</p> <p>(R5331)</p>	<p><b>Preparation</b></p> <ul style="list-style-type: none"> <li>Remove the front panel according to "Removal of Air Filters / Front Panel".</li> </ul>
1 Remove the screw of the service cover.	<p>(R5332)</p>	<ul style="list-style-type: none"> <li>You can remove the front grille without detaching the service cover.</li> </ul>
2. Remove the front grille.	<p>Front grille</p> <p>(R5333)</p>	
1 Remove the 3 screws of the front grille.		

Step	Procedure	Points
2	Release the 3 hooks on the top of the front grille.	<ul style="list-style-type: none"> <li>■ The front grille has 3 hooks on the center and the both sides of the upper part.</li> <li>■ Refer to the removal procedure in a reverse way when reassembling.</li> </ul>
3	Pull the upper part of the front grille out and lift the lower part up, and then remove the front grille.	<ul style="list-style-type: none"> <li>■ The convex marks (...) on the front panel indicate the position of the hooks.</li> <li>■ Make sure that all the 3 hooks are placed securely when reassembling.</li> </ul>

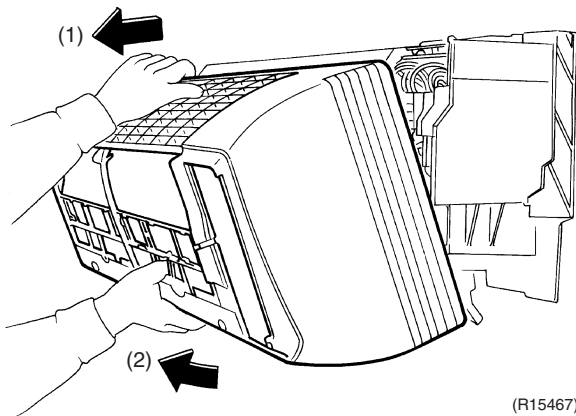
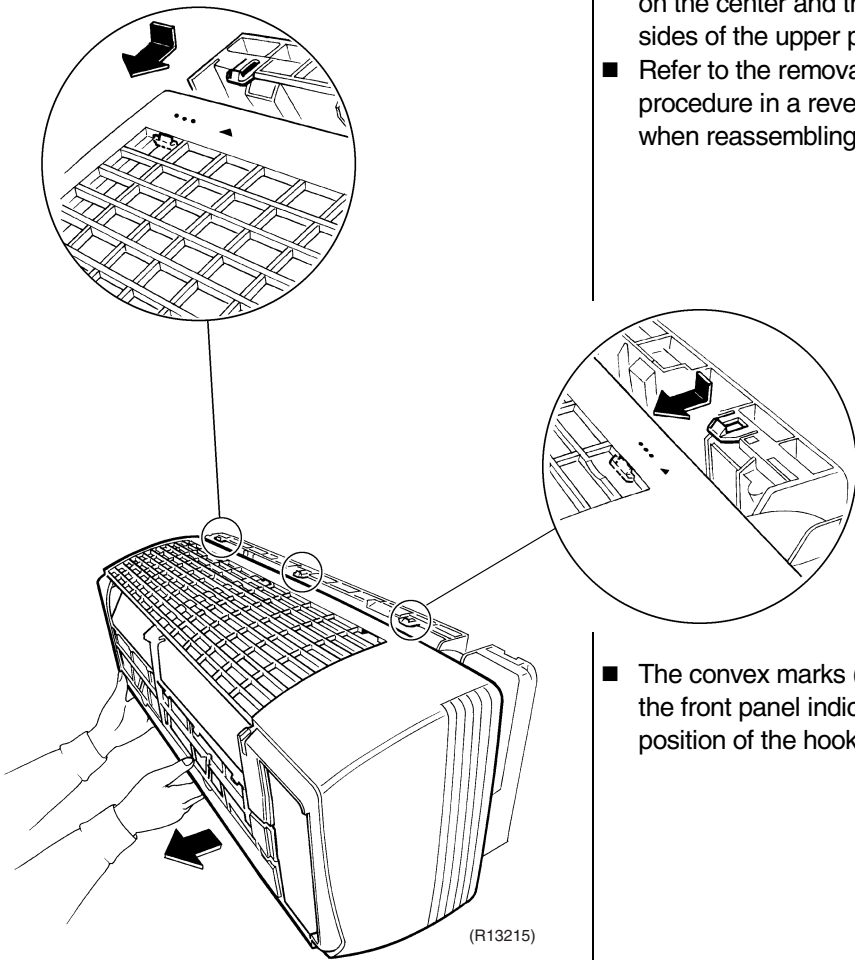



### 3. Removal of Horizontal Blades / Vertical Blades

#### Procedure

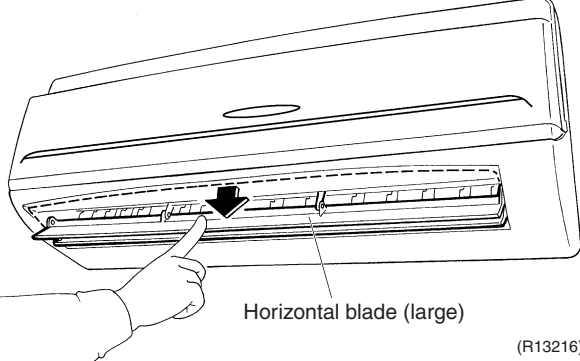
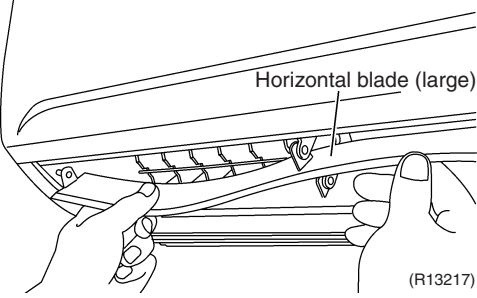
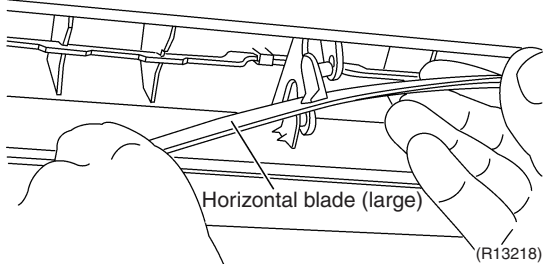
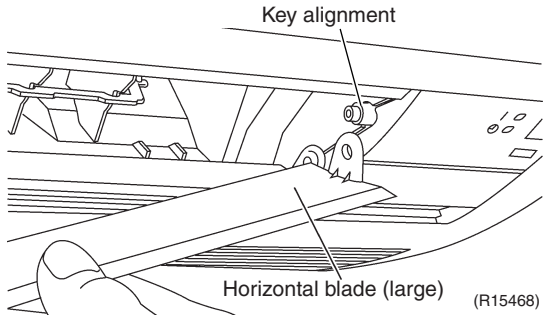

**Warning** Be sure to wait for 10 minutes or more after turning off all power supplies before disassembling work.

Step	Procedure	Points
1. Remove the horizontal blades.	 <p>Horizontal blade (large) (R13216)</p>	
1 Open the horizontal blade (large).	 <p>Horizontal blade (large) (R13217)</p>	
2 Release the left shaft of the horizontal blade.	 <p>Horizontal blade (large) (R13218)</p>	
3 Bend the horizontal blade slightly and release the 2 center shafts. Slide the horizontal blade to the left and release the right shaft.	 <p>Key alignment (R15468)</p> <p>Horizontal blade (large) (R15468)</p>	<ul style="list-style-type: none"> <li>■ There is a key alignment at the right shaft. When reassembling, insert the right shaft first while turning.</li> <li>■ After inserting the right shaft, mount the horizontal blade to the center shaft and then to the left shaft.</li> </ul>

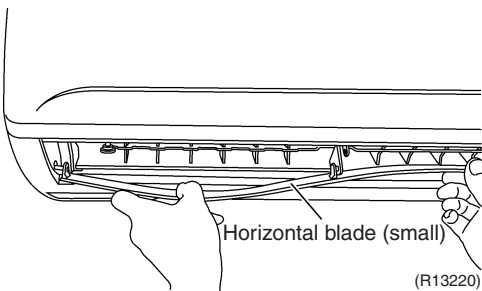
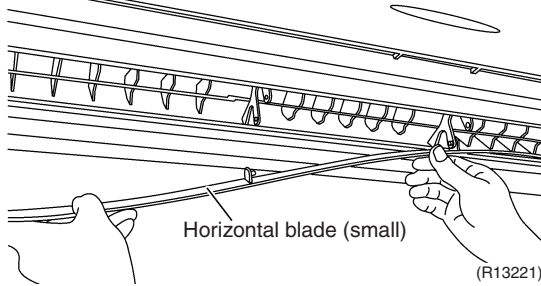
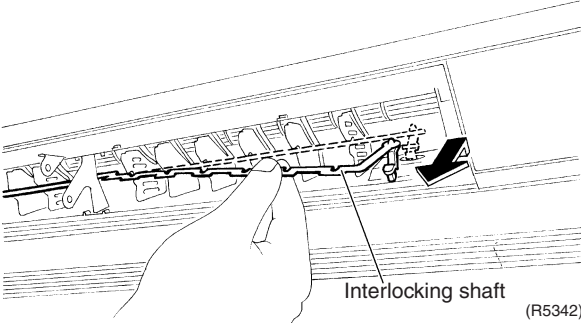
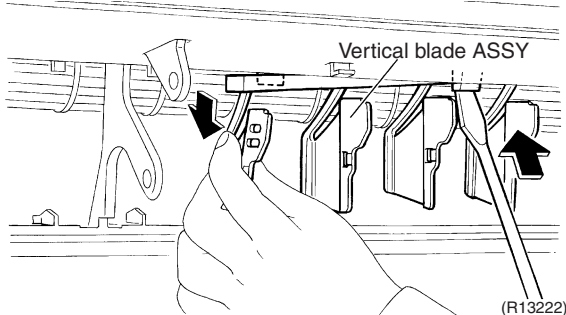
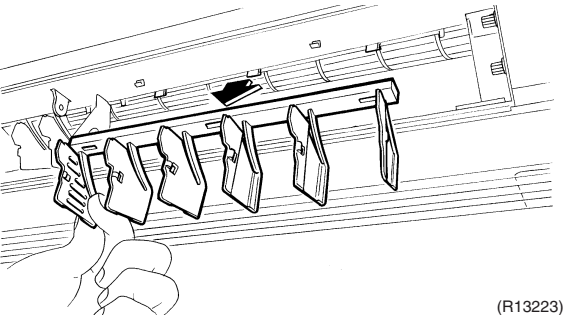
Step	Procedure	Points
4	Remove the horizontal blade (small) in the same methods.	
	 <p>Horizontal blade (small)</p> <p>(R13220)</p>  <p>Horizontal blade (small)</p> <p>(R13221)</p>	
2. Remove the vertical blade ASSY.		
1	Remove the interlocking shaft for the vertical blades.	
	 <p>Interlocking shaft</p> <p>(R5342)</p>	
2	Release the 3 hooks with a flat screwdriver and remove the vertical blade ASSY.	
	 <p>Vertical blade ASSY</p> <p>(R13222)</p>  <p>(R13223)</p>	

## 4. Removal of Electrical Box

### Procedure



**Warning** Be sure to wait for 10 minutes or more after turning off all power supplies before disassembling work.

Step	Procedure	Points
1. Disconnect the each harness.	<p>(R5345)</p>	<p><b>Preparation</b></p> <ul style="list-style-type: none"> <li>Remove the front grille according to "Removal of Front Grille".</li> </ul>
1 Remove the screw and remove the drip proof plate.	<p>Drip proof plate</p> <p>(R5346)</p>	<ul style="list-style-type: none"> <li>Be careful not to lose the clip for the thermistor.</li> </ul>
2 Remove the screw of the earth / ground wire and cut the clamp.	<p>Indoor heat exchanger thermistor</p> <p>Earth / ground wire</p> <p>(R19164)</p>	<p>Clip</p> <p>(R11234)</p>
3 Pull out the indoor heat exchanger thermistor.	<p>[S1]</p> <p>(R5348)</p>	
4 Disconnect the connector for the fan motor [S1].		

Step	Procedure	Points
5	Disconnect the connector for the swing motor [S6], [S8].	[S6]: for horizontal blade [S8]: for vertical blade
6	Disconnect all the connection wirings.	■ Some models have no harness for [S8].
7	Remove the screw and remove the wire clamp.	
2. Remove the electrical box.		
1	Remove the screw of the electrical box.	
2	Lift up the lower part of the electrical box.	
3	Release the upper hook to remove.	
	<p>(R16543)</p>	
	<p>(R10827)</p>	
	<p>(R5351)</p>	
	<p>(R5352)</p>	<ul style="list-style-type: none"> <li>■ The electrical box has a hook on its back.</li> <li>■ When reassembling, catch the back hook of the electrical box.</li> </ul>

## 5. Removal of PCBs

### Procedure



### Warning

Be sure to wait for 10 minutes or more after turning off all power supplies before disassembling work.

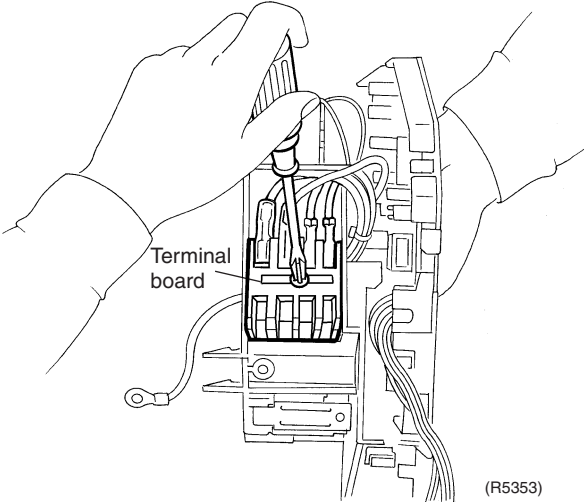
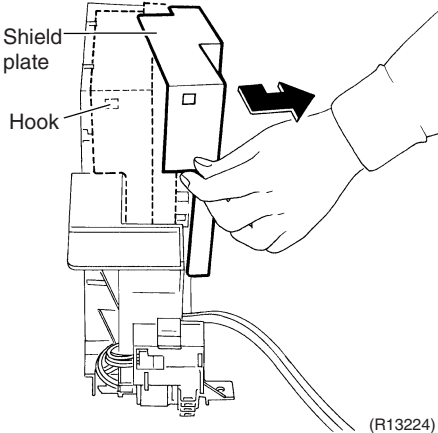
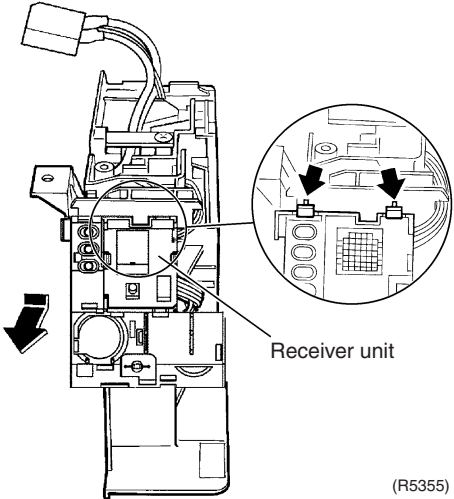
Step	Procedure	Points
1	<p>Remove the screw of the terminal board.</p>  <p style="text-align: right;">(R5353)</p>	
2	<p>Release the 3 hooks to remove the shield plate.</p>  <p style="text-align: right;">(R13224)</p>	<ul style="list-style-type: none"> <li>■ The shield plate also has 2 hooks on the upper side.</li> </ul>
3	<p>Press the receiver unit down to release the upper hooks, and then release the lower hooks.</p>  <p style="text-align: right;">(R5355)</p>	

Step	Procedure	Points
4	Cut the clamp and detach the harness from the hook.	<ul style="list-style-type: none"> <li>■ Clamps should be always attached. Fix it as it was before.</li> </ul>
5	The receiver unit has 3 PCBs. From the back side, release the 3 hooks to remove the buzzer PCB, and release the 2 hooks to remove the display PCB.	
6	Release the 2 hooks to remove the signal receiver PCB.	
7	Remove the screw to detach the power supply terminal unit.	

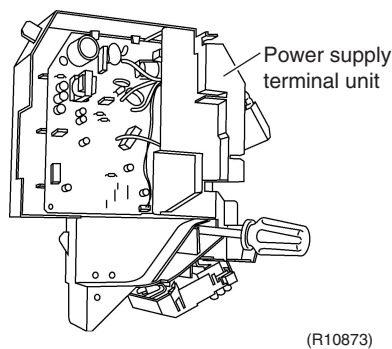
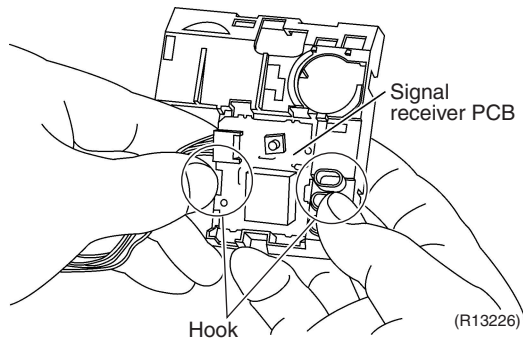
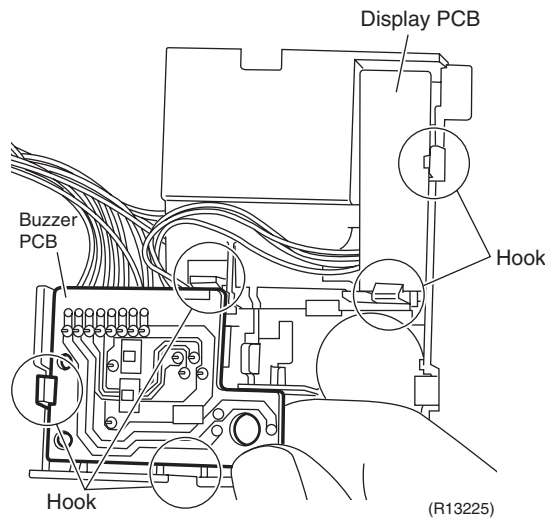
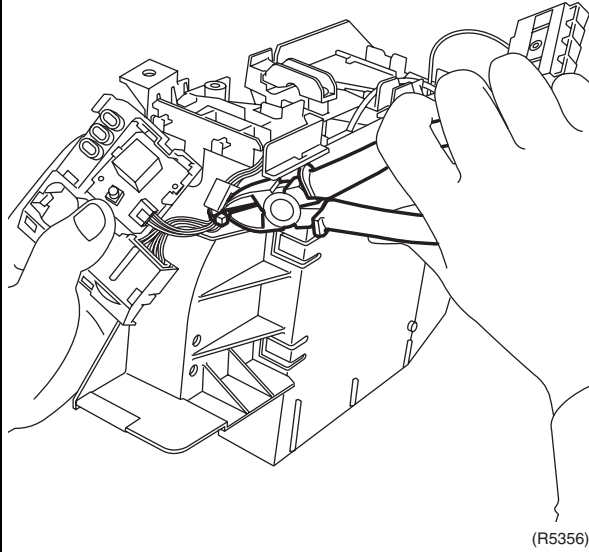

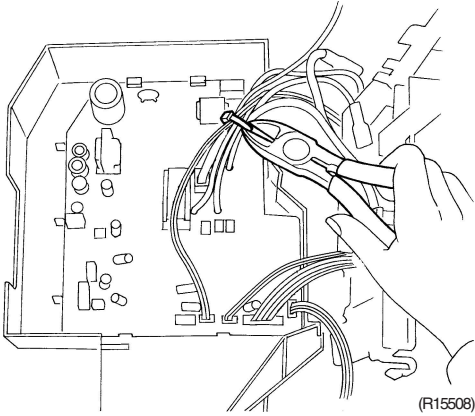
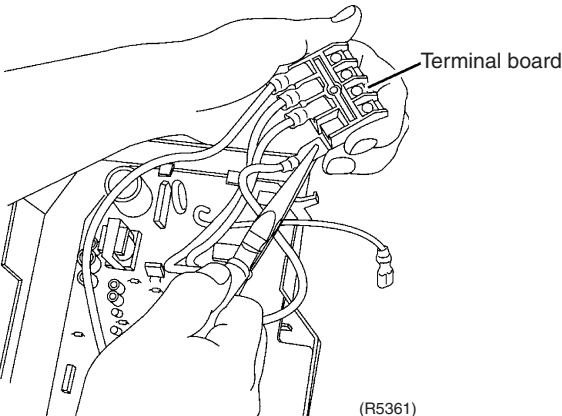
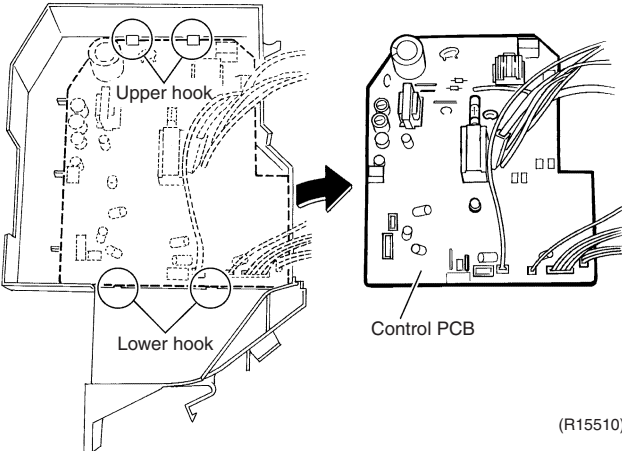
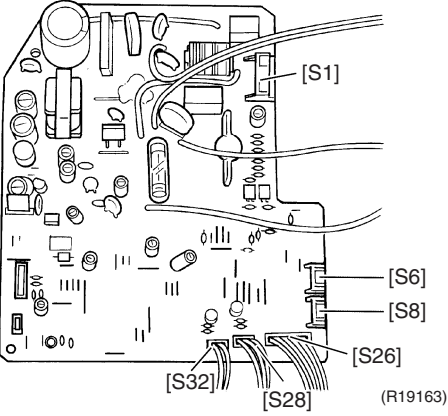
Step	Procedure	Points
8	Cut the clamp.	
	 <p>(R15508)</p>	
9	Disconnect the terminals from the terminal board.	
	 <p>Terminal board</p> <p>(R5361)</p>	
10	Release the 2 lower hooks first, and then release the 2 upper hooks to remove the control PCB.	
	 <p>Upper hook</p> <p>Lower hook</p> <p>Control PCB</p> <p>(R15510)</p>	
11	Control PCB	
	 <p>[S1]</p> <p>[S6]</p> <p>[S8]</p> <p>[S26]</p> <p>[S32]</p> <p>[S28]</p> <p>(R19163)</p>	<p>[S1]: DC fan motor                  [S6]: swing motor for horizontal blades                  [S8]: swing motor for vertical blades                  [S26]: buzzer PCB                  [S28]: signal receiver PCB                  [S32]: indoor heat exchanger thermistor</p> <p>■ Some models have no harness for [S8].</p>

# 6. Removal of Swing Motors

**Procedure**



**Warning** Be sure to wait for 10 minutes or more after turning off all power supplies before disassembling work.

Step	Procedure	Points
1. Remove the swing motor for horizontal blades.	<p>Swing motor for horizontal blades (R5364)</p>	<p><b>Preparation</b></p> <ul style="list-style-type: none"> <li>Remove the electrical box according to "Removal of Electrical Box".</li> </ul>
1 Remove the screw and remove the swing motor for horizontal blades.	<p>Swing motor for horizontal blades (R5364)</p>	<p><b>Preparation</b></p> <ul style="list-style-type: none"> <li>Remove the electrical box according to "Removal of Electrical Box".</li> </ul>
2. Remove the swing motor for vertical blades.	<p>(R2789)</p> <p>Swing motor assembly (R2791)</p>	<ul style="list-style-type: none"> <li>Releasing the swing axis                             <ul style="list-style-type: none"> <li>(1) Undo the claw.</li> <li>(2) Pull it out. (R2790)</li> </ul> </li> </ul>
1 Release the swing axis on the right side.	<p>(R2789)</p> <p>Swing motor assembly (R2791)</p>	<ul style="list-style-type: none"> <li>Releasing the swing axis                             <ul style="list-style-type: none"> <li>(1) Undo the claw.</li> <li>(2) Pull it out. (R2790)</li> </ul> </li> </ul>
2 Loosen the 2 screws and detach the swing motor assembly.	<p>(R2789)</p> <p>Swing motor assembly (R2791)</p>	<ul style="list-style-type: none"> <li>Releasing the swing axis                             <ul style="list-style-type: none"> <li>(1) Undo the claw.</li> <li>(2) Pull it out. (R2790)</li> </ul> </li> </ul>

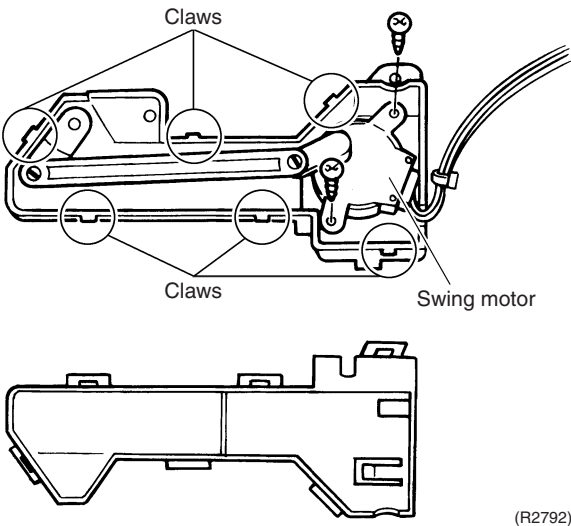

Step	Procedure	Points
3	Loosen the 2 screws and remove the swing motor.	■ 6 claws hold the assembly.
 <p>(R2792)</p>		

# 7. Removal of Indoor Heat Exchanger

**Procedure**



**Warning** Be sure to wait for 10 minutes or more after turning off all power supplies before disassembling work.

Step	Procedure	Points
1. Disconnect the refrigerant piping.	<p>(R5370)</p>	<p><b>Preparation</b></p> <ul style="list-style-type: none"> <li>Remove the electrical box according to "Removal of Electrical Box".</li> </ul>
1 Hold the indoor unit up with a piece of wood etc.	<p>Drain hose</p> <p>(R15469)</p>	<p><b>Caution</b></p> <p>If refrigerant leaks, repair the spot of leaking, then collect all refrigerant from the unit. After conducting vacuum drying, recharge proper amount of refrigerant.</p>
2 Cover the drain hoses with vinyl covers.	<p>(R5372)</p>	<p><b>Caution</b></p> <p>In pump-down work, be sure to stop the compressor before disconnecting the refrigerant pipe. If the refrigerant pipe is disconnected with the compressor operating and the stop valve open, air may be sucked in and may generate an over-pressure in refrigeration cycle, thus resulting in pipe rupture or accidental injury.</p>
3 Unscrew the flare nut for gas piping.	<p>(R5373)</p>	<ul style="list-style-type: none"> <li>Place a plastic sheet under the drain pan to prevent from wetting the floor with remaining drain.</li> <li>If the drain hose is embedded in the wall, disconnect the drain hose beforehand.</li> <li>Carry out the removal works with 2 wrenches.</li> <li>When the pipings are disconnected, protect both the openings of pipe and unit from entering of moisture.</li> </ul>
4 Unscrew the flare nut for liquid piping.		

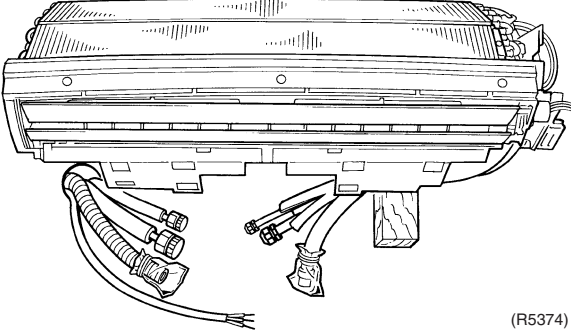
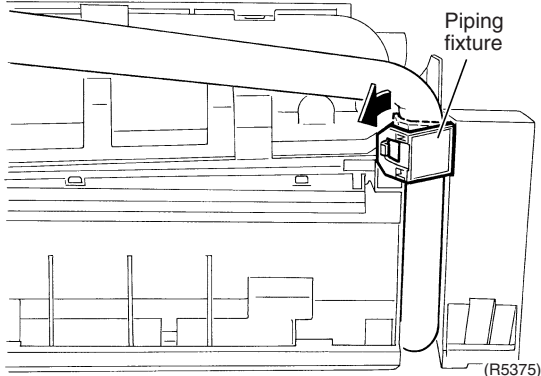
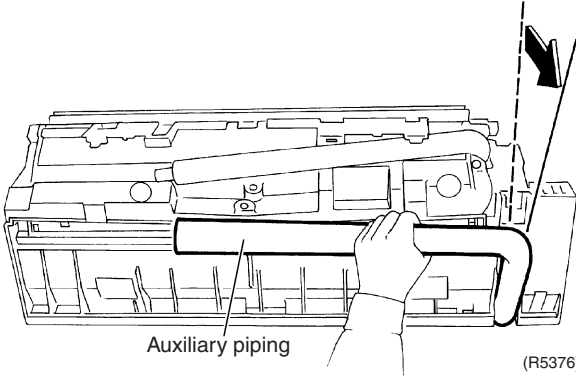
Step	Procedure	Points
2. Remove the indoor unit.	 <p>(R5374)</p>	
3. Remove the indoor heat exchanger.	<p data-bbox="150 826 464 954">1 Unfasten the hook of the piping fixture at the back of the indoor unit and pull out the piping.</p>  <p data-bbox="150 1211 400 1272">2 Slightly widen the auxiliary piping.</p>  <p data-bbox="635 1585 783 1615">Auxiliary piping</p> <p data-bbox="948 819 1011 864">Piping fixture</p> <p data-bbox="991 1167 1050 1189">(R5375)</p> <p data-bbox="1011 1608 1070 1630">(R5376)</p>	

Step	Procedure	Points
3	Unfasten the hooks on the left side of the indoor heat exchanger.	 <b>Caution</b> When removing or reassembling the indoor heat exchanger, be sure to wear protective gloves or wrap the indoor heat exchanger with cloths. (You may be injured by the fins.)
4	Push to release the fixing hooks on the right side.	
5	Pull the indoor heat exchanger to the front side and release the hooks completely, and then lift it.	

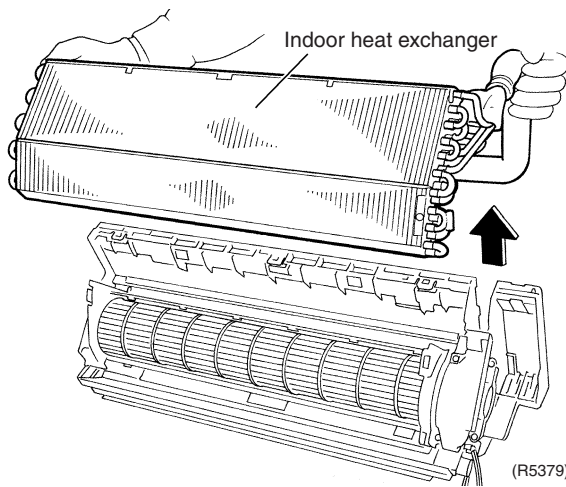
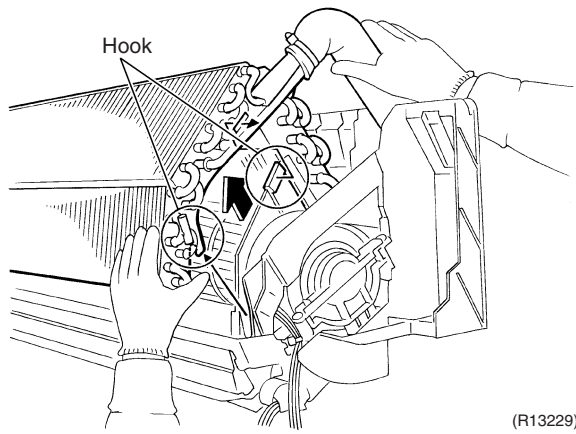
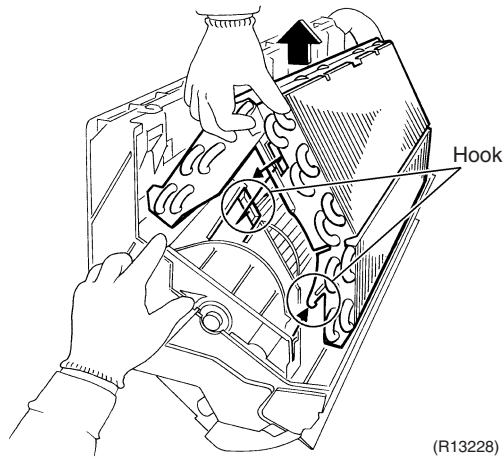

## 8. Removal of Fan Rotor / Fan Motor

### Procedure

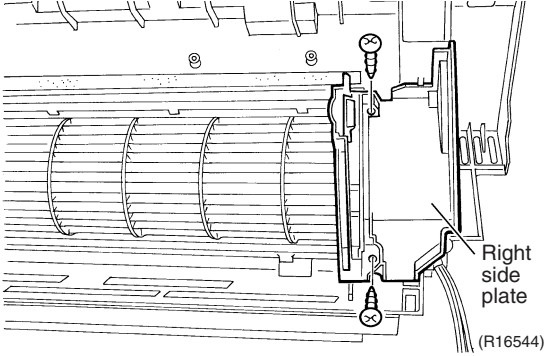
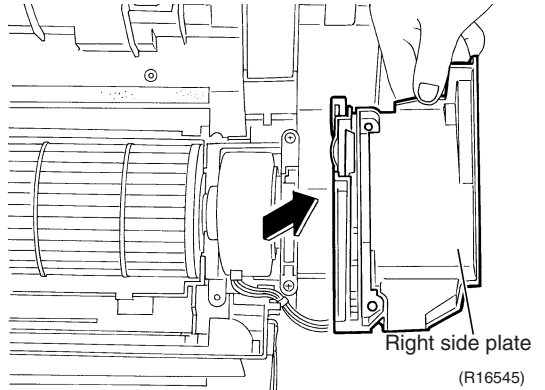
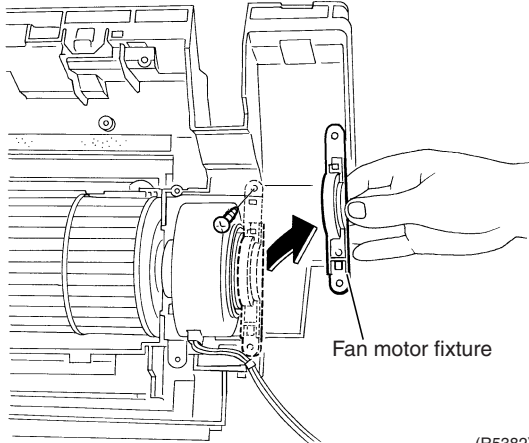
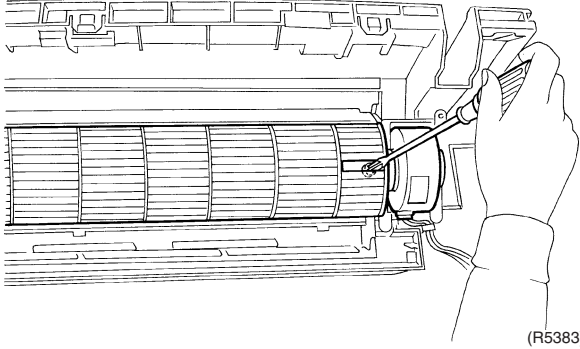

**Warning** Be sure to wait for 10 minutes or more after turning off all power supplies before disassembling work.

Step	Procedure	Points
<p>1. Remove the right side plate.</p> <p>1 Remove the 2 screws of the right side plate.</p> <p>2 Lift the right side plate and remove it.</p>	 <p>Right side plate (R16544)</p>  <p>Right side plate (R16545)</p>	<ul style="list-style-type: none"> <li>■ You can remove the fan rotor without detaching the right side plate.</li> </ul>
<p>2. Remove the fan rotor.</p> <p>1 Remove the screw and remove the fan motor fixture.</p> <p>2 Loosen the fixing screw of the fan rotor.</p>	 <p>Fan motor fixture (R5382)</p>  <p>(R5383)</p>	

Step	Procedure	Points
3	Remove the fan rotor.	<ul style="list-style-type: none"> <li>When reassembling the fan motor and the fan rotor, provide as much as 5 mm of play between the side face of the rotor and the bottom frame.</li> </ul>
3. Remove the bearing.	<div data-bbox="488 259 1070 674"> <p>(R13230)</p> </div> <div data-bbox="488 730 1070 1066"> <p>(R5385)</p> </div> <div data-bbox="488 1133 1070 1480"> <p>(R16546)</p> </div> <div data-bbox="488 1559 1070 1917"> <p>(R5387)</p> </div>	<div data-bbox="1110 427 1445 719"> <p>(R2808)</p> </div> <div data-bbox="1110 775 1445 1077"> <p>(R9582)</p> </div> <ol style="list-style-type: none"> <li>Insert the fan motor with approx. 5 mm left.</li> <li>Tighten the screw until it stops. Then give the screw one more turn.</li> <li>Rotate the fan rotor and confirm the fan motor and the fan rotor are installed appropriately.</li> <li>Tighten the screw completely if appropriate.</li> <li>If not appropriate, go back to (1).</li> </ol>

## 9. Exchange of Drain Hose (Piping Direction)

### Procedure

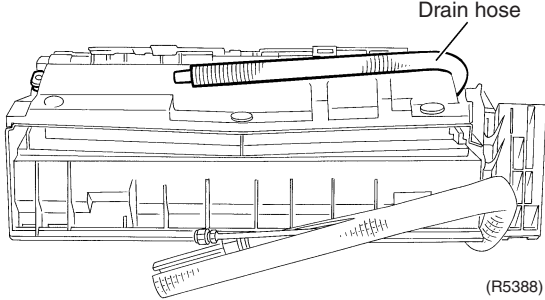
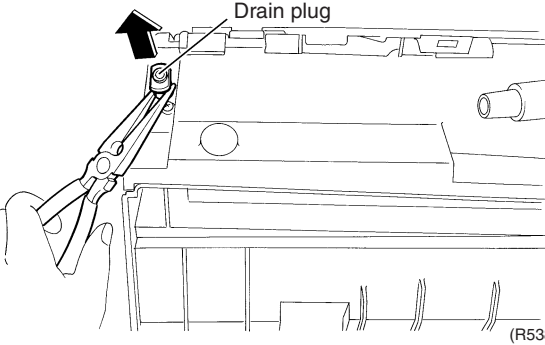
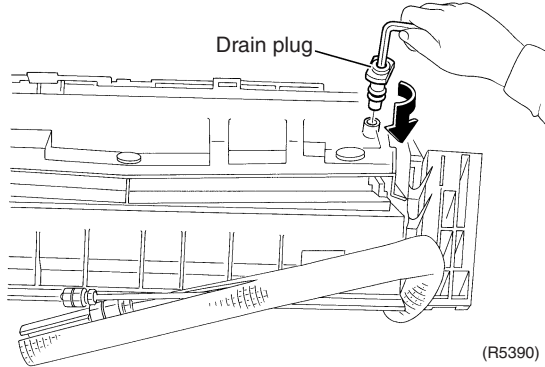
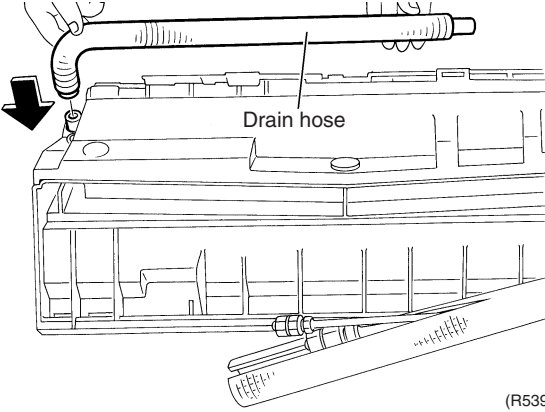

**Warning** Be sure to wait for 10 minutes or more after turning off all power supplies before disassembling work.

Step	Procedure	Points
1	Pull out the drain hose.	 <p>(R5388)</p>
2	Pull out the drain plug from the left side with pliers.	 <p>(R5389)</p>
3	Push the drain plug into the right hole with a hexagonal wrench (4 mm).	 <p>(R5390)</p>
4	Insert the drain hose into the left hole firmly.	 <p>(R5391)</p>



### Caution

Do not push the drain plug with a sharp object like a screwdriver. (The drain plug can be damaged and that causes leakage of water.)

# Revision History

Month / Year	Version	Revised contents
07 / 2013	Si04-754	First edition



Warning



- Daikin products are manufactured for export to numerous countries throughout the world. Prior to purchase, please confirm with your local authorised importer, distributor and/or retailer whether this product conforms to the applicable standards, and is suitable for use, in the region where the product will be used. This statement does not purport to exclude, restrict or modify the application of any local legislation.
- Ask a qualified installer or contractor to install this product. Do not try to install the product yourself. Improper installation can result in water or refrigerant leakage, electrical shock, fire or explosion.
- Use only those parts and accessories supplied or specified by Daikin. Ask a qualified installer or contractor to install those parts and accessories. Use of unauthorised parts and accessories or improper installation of parts and accessories can result in water or refrigerant leakage, electrical shock, fire or explosion.
- Read the User's Manual carefully before using this product. The User's Manual provides important safety instructions and warnings. Be sure to follow these instructions and warnings.

If you have any enquiries, please contact your local importer, distributor and/or retailer.

### Cautions on product corrosion

1. Air conditioners should not be installed in areas where corrosive gases, such as acid gas or alkaline gas, are produced.
2. If the outdoor unit is to be installed close to the sea shore, direct exposure to the sea breeze should be avoided. If you need to install the outdoor unit close to the sea shore, contact your local distributor.

### Dealer

### **DAIKIN INDUSTRIES, LTD.**

Head Office:  
Umeda Center Bldg., 2-4-12, Nakazaki-Nishi,  
Kita-ku, Osaka, 530-8323 Japan

Tokyo Office:  
JR Shinagawa East Bldg., 2-18-1, Konan,  
Minato-ku, Tokyo, 108-0075 Japan

[http://www.daikin.com/global\\_ac/](http://www.daikin.com/global_ac/)

©All rights reserved